



# C21 & EC21

ADVANCED TECHNOLOGY DIMMER RACK

OPERATION GUIDE



---

The material in this manual is for information purposes only and is subject to change without notice. Vari-Lite assumes no responsibility for any errors or omissions, which may appear in this manual. For comments and suggestions regarding corrections and/or updates to this manual, please contact the nearest Strand Lighting office.

El contenido de este manual es solamente para información y está sujeto a cambios sin previo aviso. Vari-Lite no asume responsabilidad por errores o omisiones que puedan aparecer. Cualquier comentario, sugerencia o corrección con respecto a este manual, favor de dirigirlo a la oficina de Strand Lighting más cercana.

Der Inhalt dieses Handbuches ist nur für Informationszwecke gedacht, Aenderungen sind vorbehalten. Vari-Lite uebernimmt keine Verantwortung für Fehler oder Irrtuemer, die in diesem Handbuch auftreten. Für Bemerkungen und Verbesserungsvorschlaege oder Vorschlaege in Bezug auf Korrekturen und/oder Aktualisierungen in diesem Handbuch, moechten wir Sie bitten, Kontakt mit der naechsten Strand Lighting-Niederlassung aufzunehmen.

Le matériel décrit dans ce manuel est pour information seulement et est sujet à changements sans préavis. La compagnie Vari-Lite n'assume aucune responsabilité sur toute erreur ou omission inscrite dans ce manuel. Pour tous commentaires ou suggestions concernant des corrections et/ou les mises à jour de ce manuel, veuillez s'il vous plait contacter le bureau de Strand Lighting le plus proche.

Document Number: 2-450174-030

Version as of: 05 February 2013

© 2006 - 2013, Philips Group. All rights reserved.

Information contained in this document may not be duplicated in full or in part by any person without prior written approval of Vari-Lite. Its sole purpose is to provide the user with detailed installation information for the equipment supplied. The use of this document for all other purposes is specifically prohibited.

---

# Preface

Thank you for choosing C21/EC21 Advanced Technology dimmer rack. We trust that the equipment will meet all your dimming needs and will provide you with reliable service for many years.

Vari-Lite can assure you that every effort has been made to ensure that the equipment has been designed to meet the highest professional standards and that dimmer racks and their components have been assembled, inspected, and tested in accordance with our strict quality assurance program.

Should you encounter any problems or difficulties with your dimmer racks, please contact the nearest Vari-Lite service representative. For a complete list of Vari-Lite offices and service centers or visit our Web site ([www.vari-lite.com](http://www.vari-lite.com)).

This manual describes the operation of for C21/EC21 Advanced Technology dimmer racks. A separate Installation Guide provided with the dimmer racks describes how to install the dimmer racks and perform initial setup procedures.

## Technical Assistance

C21/EC21 racks and dimmers require a minimum of maintenance and servicing.

For operation or technical assistance, please contact Vari-Lite or the local Authorized Service Center serving your area. ([www.vari-lite.com](http://www.vari-lite.com))

---

# Definition of Terms

This manual uses the following terms throughout:

- channel** A device controlling a dimmer or group of dimmers. Historically, there is a physical controller (such as a slider) for each channel. On most current control systems, channels are numbers accessed by a numeric keypad. Each channel can control multiple dimmers.
- circuit** A connection device and wiring for powering a lighting fixture from a dimmer.
- circuit ID** A unique four-digit numeric identity which you can assign to each dimmer. The circuit ID may be the same as the dimmer number, or may be a number used to indicate circuit location, phase, channel number, etc. This feature is useful for system wide control functions.
- crossfade** A fade that contains both an up-fade and a down-fade, or any fade where the levels of one cue are replaced by the levels of another cue.
  - cue** The process of recalling a preset from its memory location and putting the result on stage.  
  
Preset, Memory, and cue are often used interchangeably.
  - curve** The relationship between a control level and the actual dimmer output.
- dimmer** A device controlling power to a lighting fixture. Two lights on the same dimmer cannot be separately controlled.
- default** The original factory settings.
- DMX512** An ANSI communications protocol standard that describes a method of digital data transmission between controllers, lighting equipment and accessories.
- Ethernet** A high-speed network based protocol used to transmit data from a lighting controller to a dimmer rack using a single Ethernet cable.
- fade** A gradual change in stage levels from one set of intensities (“look”) to another.
- fade time** The time it takes for dimmer levels to go from their current levels to the levels in the selected preset, or DMX512 value. Each preset has its own fade time.
- IGBT** Insulated Gate Bipolar Transistor. IGBT dimmers are solid-state and operate silently without the use of chokes and can handle a variety of load types. They reduce lamp filament noise during dimming operation, are smaller, lighter, and generate far less neutral harmonics than conventional dimmers. IGBT dimming technology provides superior overload and short-circuit protection and operates at significantly higher rise/fall times regardless of load size.
- level** A numerical value used to express the “brightness” of the load on a dimmer. Usually shown as %.
- Outlook** A Strand architectural control system. Outlook was eventually replaced by another Strand architectural system called Vision.net, however, C21/EC21 racks continue to support Outlook for legacy installations.
- patch** Historically, the process of physically connecting circuits to dimmers. Now usually refers to electronic assignment of dimmers to channels.



---

<b>phase</b>	The three phases of the mains supply to which the dimmers are connected are identified as Line 1, Line 2, Line 3 in 230v markets and as phase A, phase B, and phase C in 120v markets.
<b>power module</b>	A chassis containing one, two or four dimmer or contactors. This is sometimes referred to as a “dimmer”. However, each C21/EC21 power module can have multiple dimmers or contactors in it, so this manual distinguishes between dimmers (individual power control circuits) and power modules (a collection of one or more power control circuits).
<b>preset</b>	A pre-defined setup of intensities for a set of channels, stored in memory for later replay.
<b>Preset fade time</b>	See “Fade Time”.
<b>profile</b>	The relationship between a control level and the actual dimmer output. Also known as ‘dimmer law’ or ‘curve’.
<b>rack number</b>	A number used to uniquely identify each dimmer rack in a multiple rack system. Rack numbers are set from the front panel of the rack processor module, and are usually set by the installation engineer.
<b>room</b>	An area separately defined for purposes of architectural lighting control. This is usually a room in the traditional sense (an indoor enclosed area) or a portion of a room that can be partitioned off. Each room may be separately and simultaneously controlled by the system.
<b>RPH</b>	Rack Processor Housing
<b>RPM</b>	Rack Processor Module
<b>SSR</b>	(Solid State relay) A power control device used in Strand dimmers that contains two silicon control rectifiers (SCRs), control circuitry, and optical isolation circuitry.
<b>SWC</b>	(System Wide Control) A Strand dimmer rack control system that utilized 128 backup presets. SWC was eventually replaced by another Strand architectural system called Vision.net, however, C21/EC21 racks continue to support SWC for legacy installations.
<b>Vision.net</b>	A digital architectural control system for use with C21/EC21 dimmer racks.

---

# Table of Contents

This manual describes the operation and setup of the dimmer rack. It does not contain information about installing the rack. See the separate *C21* or the *EC21 Dimmer Rack Installation Manual* for detailed information concerning installation and wiring of the dimmer rack.

<b>Section 1 - General .....</b>	<b>1</b>
Summary Specification.....	1
120V Dimmer Modules.....	3
230V Dimmer Modules.....	4
Rack Components.....	6
Dimmer Modules .....	7
Reporting Dimmer Modules .....	7
IGBT Dimmer Modules .....	8
IGBT Dimmer Module Switch Pack .....	8
Fan Module.....	9
Rack Processor Housing .....	10
Rack Processor Module .....	10
Power Supplies .....	11
Control Interconnection Card (CIC).....	11
Processor Configuration .....	11
Startup.....	11
LED Status .....	12
Rack Processor Housing LEDs .....	12
Rack Processor Module LEDs.....	12
Dimmer Events .....	12
After Startup .....	12
<b>Section 2 - Operational Features .....</b>	<b>14</b>
Rack Configuration.....	14
Dimmer Configuration .....	14
Control Inputs .....	14
Safety Features .....	15
Vision.net .....	16
<b>Section 3 - Programming the C21/EC21 Dimmer Rack.....</b>	<b>17</b>
Controls and Displays .....	17
Key Lock .....	17
Using the Menu Keypad .....	17
The Status Log.....	18
The Main Menu .....	19
Rack Identity Menu.....	19
Set Rack Name .....	19
Set Rack Location .....	19
Set Main Breaker ID .....	20
View Serial Number.....	20

---

View Dealer Info .....	20
Set Date .....	20
Set Time .....	21
View Rack Size.....	21
View Software Version .....	21
Set Rack Unique ID .....	21
Network Config Menu.....	22
Set IP Address.....	22
Set SubNet Mask.....	22
Set Host Name .....	23
Set Gateway IP.....	23
View MAC Address.....	23
Rack Config Menu.....	24
Review Module Types .....	24
Set Module Type .....	24
Set Module Type Range.....	24
Set Fan Control .....	25
Set LCD Backlight .....	25
Set LCD Contrast .....	25
Set Keypad Lock .....	25
Set Active Processor .....	26
Enable Cable Comp. ....	26
Enable VoltLoss Comp. ....	26
Save Recovery Config.....	26
Restore Saved Config .....	27
Change Pass Code .....	27
User Profile Menu.....	27
Set User Profile .....	27
Dimmer Config Menu .....	28
Set Dimmer Patch .....	28
View Full Output V.....	28
Set Full Output Volts.....	29
View Regulation Mode.....	29
Set Regulation Mode .....	29
Set Circuit Names.....	30
Autonumber Circuit ID .....	30
Load Profile Actions.....	30
Dimmer Dynamics Menu .....	31
View Response Times .....	31
Set Response Times .....	31
View Profiles.....	31
Select Profiles.....	32
View Cut Levels.....	32
Set Cut Levels .....	32
View Minimum Levels .....	33
Set Minimum Levels .....	33
View Cable Impedance.....	33
Set Cable Impedance .....	33
View Report Enables .....	34
Set Report Enables .....	34

---

View Trip Modes .....	34
Set Trip Modes .....	34
Input Config Menu .....	35
Set DMX A Options .....	35
Set DMX A Label .....	35
Set DMX B Options .....	36
Set DMX B Label .....	36
Set Panic Options .....	36
Enable AV Port .....	36
Enable SMX Sharing .....	39
Set SMX Sharing Group .....	39
Enable SVN Sharing .....	40
SWC Menu .....	40
Call SWC Preset .....	40
Record SWC Preset .....	40
Set No Mux Preset .....	41
Set No Mux Hold Time .....	41
Set No Mux NetSlot .....	41
Set Fade Time .....	41
Set Fade Time Range .....	41
Edit SWC Event List Editor .....	42
Set Power-Up Preset .....	42
Outlook Menu .....	42
Call Outlook Preset .....	42
Call Outlook Pr. Range .....	43
Record Outlook Preset .....	43
Record Outlook Pr. Range .....	43
Set Channel Levels .....	43
Set Ch. Levels Range .....	43
Set Outlook Fade Time .....	43
Set Fade Time Range .....	43
Set Power-up Preset .....	43
Review Outlook Patch .....	43
Set Outlook Patch .....	44
Set Outlook Defaults .....	44
Local Control Menu .....	44
Set Dimmer Level .....	44
Set Dimmer Level Range .....	45
Call SWC Preset .....	45
Call Outlook Preset .....	45
Status Reporting Menu .....	46
View Live Status .....	46
View Rack Status .....	46
View Event Log .....	46
View Profile Stats .....	46
View Comm Stats .....	47
View System Up-Time .....	47
Set Temperature Scale .....	47
Set Level Display .....	47
Set Event Config .....	48

---

Enable Load Errors.....	48
Factory Menu .....	48
Set Rack Model .....	48
Set Rack Backplane .....	49
Set Rack Mains .....	49
Set Phase Config.....	49
Set Rack Size .....	50
Set Rack Slot Order.....	50
Set Rack Slot Usage .....	50
Rack Calibration Sub-Menu.....	51
Set Phase Sense Trim.....	51
Set Phase Filters .....	51
Revert to Mfg. Config.....	51
EEPROM Test Write.....	52
EEPROM Test Read .....	52
View Serial Number.....	52
Set Language .....	52
Set Project Name .....	52
Set Dealer Name.....	53
Set Dealer Contact .....	53
Set Dealer Extra Info. ....	53
Reboot Rack.....	53
Hide Factory Menu .....	54
<b>Section 4 – C21/EC21 Web Pages.....</b>	<b>55</b>
General .....	55
Web Page Main Screen.....	55
Web Page Authorization.....	55
Web Page Setup .....	56
Web Page System Parameters .....	57
Web Page System Construction.....	58
Web Page Construction Slots.....	58
Web Page Dimmer Modules.....	59
Web Page Dimmer Circuits .....	60
Web Page Dimmer Dynamics.....	61
Web Page Dimmer User Profiles.....	61
Web Page Dimmer Tolerance .....	62
Web Page Dimmer Reporting.....	62
Web Page Dimmer Patch .....	63
Web Page Firmware Update .....	63
Web Page Local Control.....	64
Notes .....	65

---

## Table of Figures

Figure 1 – C21/EC21 Dimmer Rack Fully Populated .....	6
Figure 2 – Dual Dimmer Module .....	7
Figure 3 – DIP Switch Settings .....	9
Figure 4 – Fan Module .....	10
Figure 5 – Rack Processor Housing .....	10
Figure 6 – Rack Processor Module .....	11
Figure 7 - Processor Module Front Panel .....	12
Figure 8 - Rack Processor Module Front Panel .....	17

---

# Section 1 - General

## Summary Specification

### Dimmer Rack Specifications:

Capacity:	Large rack: 48 Dimmer Modules Small rack: 24 Dimmer Modules
Supply:	90 to 264VAC, 3-phase, neutral + earth, 47 to 63 Hz
Max Current (per phase):	Large rack: 800 amps (120V markets), 800 amps (230V markets) Small rack: 800 amps (120V markets), 400 amps (230V markets)
Dimensions:	Large rack: Height 80" (2032mm), Width 24.36" (619mm), Depth, 23.62" (600mm) Small rack: Height 57" (1448mm), Width 24.36" (619mm), Depth, 23.62" (600mm)
Weight:	Large rack: 300 lbs. (136 Kg) empty and 690 lbs. (310 Kg) with all modules and electronics installed. Small rack: 240 lbs. (109Kg) empty and 512 lbs. (232Kg) with all modules and electronics installed.
Busbar Rating:	50,000 AIC standard or 100,000 AIC optional
Control Circuit Isolation:	Optical isolation between high voltage and control electronics is 2500VAC. Control inputs are opto-isolated from the processor at 2500VAC, offering double optical isolation between the controller and high power circuits.
Storage Temp:	-40°C to 70°C
Operating Temp:	1°C to 40°C ambient
Storage Humidity:	0% to 95%, relative humidity, non-condensing
Operating Humidity:	10% to 95%, relative humidity, non-condensing

**Note:** All specifications are correct at the time of going to press. In the interest of continuous product improvement Vari-Lite reserves the right to change specifications without notice.

---

### Dimmer Modules Specifications:

RCD:	Residual Current Device with circuit protection.
Circuit protection:	Appropriately sized fully magnetic or thermal/magnetic circuit breaker of 10,000 AIC (15A, 20A, 50A & 100A @ 120V) or 50,000 AIC (15A, 25A & 50A @ 230V) fault current rating.
Load regulation:	Dimmers will maintain their output within +/- 1% of the set output with load changes from 1kW to the maximum rating of the dimmer.
Line compensation:	The system regulates dimmer outputs to within 1V over operating voltage range. Each dimmer is individually regulated.
Efficiency:	Minimum power efficiency for dimmers is 97% at full load. Maximum full load dimmer loss is 3V RMS. Contactor non-dim power efficiency is 99%.
DC component of output:	Less than 1 volt with tungsten loads from 60W to the maximum rating of the dimmer, at all control levels.
Input response time:	The response time (time between OFF and 100%) can be set to 'Fast' (30msec), 'Medium' (100ms), 'Slow' (300ms), 'Very Slow' (700ms) or 'Glacial (1000ms). <b>The default is medium (100ms).</b>

**Note:** All specifications are correct at the time of going to press. In the interest of continuous product improvement Vari-Lite reserves the right to change specifications without notice.



**120V Dimmer Modules** The following dimmer & non-dim modules are currently available for the 120V markets:

Catalog #	Ampacity	Kw	Type	Reporting	Number of Chans	Load
76562	20A	2.4kW	Basic	No	Dual	Incan.
76563	20A	2.4kW	Standard	No	Dual	Incan.
76565	20A	2.4kW	Constant	No	Dual	Incan.
76566	20A	2.4kW	Nondim	No	Dual	Incan.
76570	20A	2.4kW	Constant	Yes	Dual	Incan.
76571	20A	2.4kW	Nondim	Yes	Dual	Incan.
76574	50A	6.0kW	Basic	No	Single	Incan.
76577	50A	6.0kW	Constant	No	Single	Incan.
76578	50A	6.0kW	Nondim	No	Single	Incan.
76582	50A	6.0kW	Constant	Yes	Single	Incan.
76583	50A	6.0kW	Nondim	Yes	Single	Incan.
76584	100A	12.0kW	Constant	No	Single	Incan.
76585	100A	12.0kW	Basic	No	Single	Incan.
76586	100A	12.0kW	Constant	Yes	Single	Incan.
76587	100A	12.0kW	Basic	Yes	Single	Incan.
76588	Blank	N/A	N/A	No	N/A	N/A
76592	20A	2.4kW	IGBT	Yes	Dual	Incan.
76593	50A	5kW	IGBT	Yes	Single	Incan.

**230V Dimmer Modules** The following dimmer & non-dim modules are currently available for the 230V markets:

Catalog #	Ampacity	Kw	Type	Reporting	Number of Chans	Load
76601	16A	3.0kW	Standard	No	Dual	Tungsten
76602	16A	3.0kW	Standard	No	Dual	Tungsten
76603	16A	3.0kW	Standard	No	Dual	Tungsten
76604	16A	3.0kW	Hi-Rise	No	Dual	Tungsten
76605	16A	3.0kW	Hi-Rise	No	Dual	Tungsten
76606	16A	3.0kW	Hi-Rise	No	Dual	Tungsten
76607	16A	3.0kW	Standard	Yes	Dual	Tungsten
76608	16A	3.0kW	Standard	Yes	Dual	Tungsten
76609	16A	3.0kW	Standard	Yes	Dual	Tungsten
76610	16A	3.0kW	Hi-Rise	Yes	Dual	Tungsten
76611	16A	3.0kW	Hi-Rise	Yes	Dual	Tungsten
76612	16A	3.0kW	Hi-Rise	Yes	Dual	Tungsten
76613	25A	5.0kW	Standard	No	Dual	Tungsten
76614	25A	5.0kW	Standard	No	Dual	Tungsten
76615	25A	5.0kW	Standard	No	Dual	Tungsten
76616	25A	5.0kW	Hi-Rise	No	Dual	Tungsten
76617	25A	5.0kW	Hi-Rise	No	Dual	Tungsten
76618	25A	5.0kW	Hi-Rise	No	Dual	Tungsten
76619	25A	5.0kW	Standard	Yes	Dual	Tungsten
76620	25A	5.0kW	Standard	Yes	Dual	Tungsten
76621	25A	5.0kW	Standard	Yes	Dual	Tungsten
76622	25A	5.0kW	Hi-Rise	Yes	Dual	Tungsten
76623	25A	5.0kW	Hi-Rise	Yes	Dual	Tungsten
76624	25A	5.0kW	Hi-Rise	Yes	Dual	Tungsten
76625	50A	10.0kW	Standard	No	Single	Tungsten
76626	50A	10.0kW	Standard	No	Single	Tungsten
76627	50A	10.0kW	Standard	No	Single	Tungsten
76628	50A	10.0kW	Hi-Rise	No	Single	Tungsten
76629	50A	10.0kW	Hi-Rise	No	Single	Tungsten
76630	50A	10.0kW	Hi-Rise	No	Single	Tungsten
76631	50A	10.0kW	Standard	Yes	Single	Tungsten
76632	50A	10.0kW	Standard	Yes	Single	Tungsten
76633	50A	10.0kW	Standard	Yes	Single	Tungsten
76634	50A	10.0kW	Hi-Rise	Yes	Single	Tungsten
76635	50A	10.0kW	Hi-Rise	Yes	Single	Tungsten
76636	50A	10.0kW	Hi-Rise	Yes	Single	Tungsten

Catalog #	Ampacity	Kw	Type	Reporting	Number of Chans	Load
76643	16A	3.0kW	Fluor	No	Single	Fluor.
76644	16A	3.0kW	Fluor	No	Single	Fluor.
76645	16A	3.0kW	Fluor	No	Single	Fluor.
76646	16A	3.0kW	Nondim	No	Dual	Tungsten
76647	16A	3.0kW	Nondim	No	Dual	Tungsten
76648	16A	3.0kW	Nondim	No	Dual	Tungsten
76649	16A	3.0kW	Nondim	Yes	Dual	Tungsten
76650	16A	3.0kW	Nondim	Yes	Dual	Tungsten
76651	16A	3.0kW	Nondim	Yes	Dual	Tungsten
76652	25A	5.0kW	Nondim	No	Dual	Tungsten
76653	25A	5.0kW	Nondim	No	Dual	Tungsten
76654	25A	5.0kW	Nondim	No	Dual	Tungsten
76655	25A	5.0kW	Nondim	Yes	Dual	Tungsten
76656	25A	5.0kW	Nondim	Yes	Dual	Tungsten
76657	25A	5.0kW	Nondim	Yes	Dual	Tungsten
76658	16A	3.0kW	Constant	No	Dual	Tungsten
76659	16A	3.0kW	Constant	No	Dual	Tungsten
76660	16A	3.0kW	Constant	No	Dual	Tungsten
76661	16A	3.0kW	Constant	Yes	Dual	Tungsten
76662	16A	3.0kW	Constant	Yes	Dual	Tungsten
76663	16A	3.0kW	Constant	Yes	Dual	Tungsten
76664	25A	5.0kW	Constant	No	Dual	Tungsten
76665	25A	5.0kW	Constant	No	Dual	Tungsten
76666	25A	5.0kW	Constant	No	Dual	Tungsten
76667	25A	5.0kW	Constant	Yes	Dual	Tungsten
76668	25A	5.0kW	Constant	Yes	Dual	Tungsten
76669	25A	5.0kW	Constant	Yes	Dual	Tungsten
76674	16A	2.5kW	IGBT	Yes	Dual	Incan.
76675	16A	2.5kW	IGBT	Yes	Dual	Incan.
76676	25A	5.0kW	IGBT	Yes	Single	Incan.
76677	25A	5.0kW	IGBT	Yes	Single	Incan.

## Rack Components

The C21/EC21 dimmer rack is a listed, free standing, factory assembly of steel and aluminum construction finished in a fine textured, scratch resistant coating.

Each C21/EC21 dimmer rack consists of a rack processor housing (RPH) with one or two rack processor modules (RPM), a fan module, and up to 24 or 48 dimmer modules. The dimmer connectors at the back of the rack provide for line wire connection. Main bus bars are provided for line wire connections. An earth ground lug is provided in the rack. The dimmer connectors in the rack are polarized to prevent dimmer modules being plugged into the different ampacity slots. The dimmer racks can be individually fed or bused together using an optional busing kit.

Large dimmer racks have provision for up to 48 dimmer modules. Small dimmer racks have provisions for up to 24 dimmer modules. Dimmer modules contain one, two or four dimmers, and dimmer module types can be mixed within a rack in various combinations.

### ITEMS:

- |                            |   |
|----------------------------|---|
| ① RJ45 ETHERNET JACK       | ⑥ PROCESSOR MODULE                                      |
| ② DIMMER MODULES           | ⑦ FEED WIRING CHAMBER                                   |
| ③ MODULE TRAYS             | ⑧ 3-PHASE, 4-WIRE BUSS<br>(SHORT CIRCUIT RATING = 50KA) |
| ④ FAN MODULE               | ⑨ HINGED REMOVABLE DOOR                                 |
| ⑤ SIGNAL TERMINATION BOARD |   |

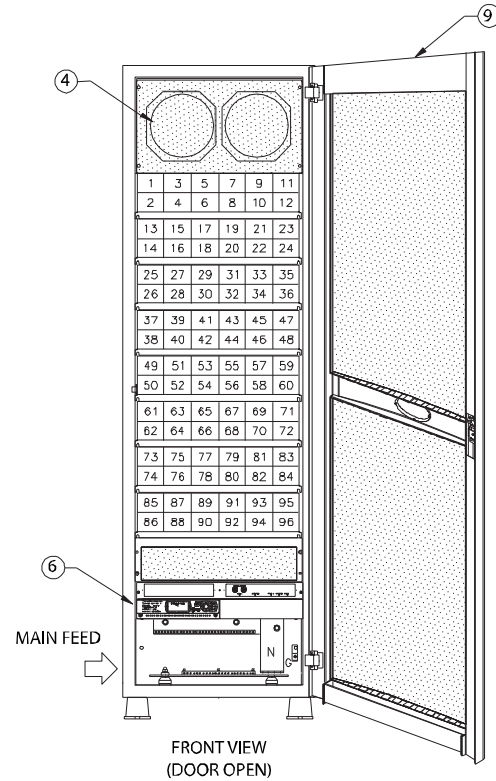
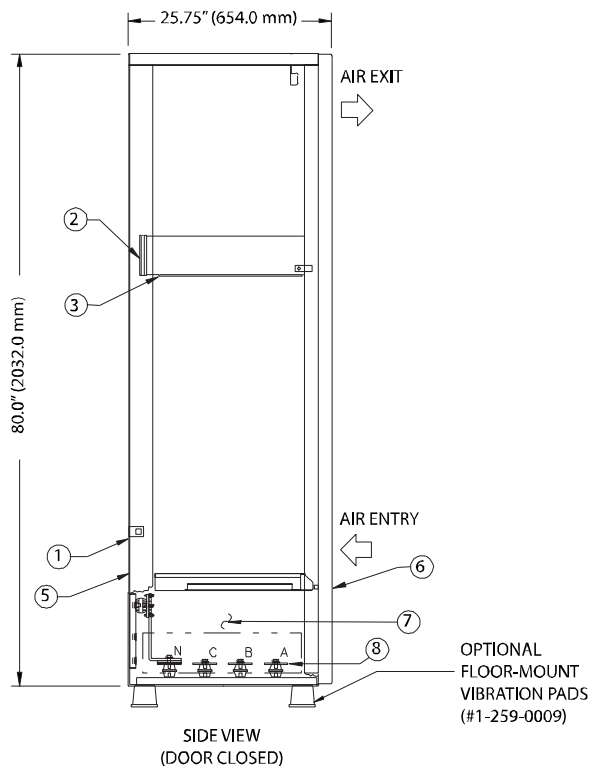
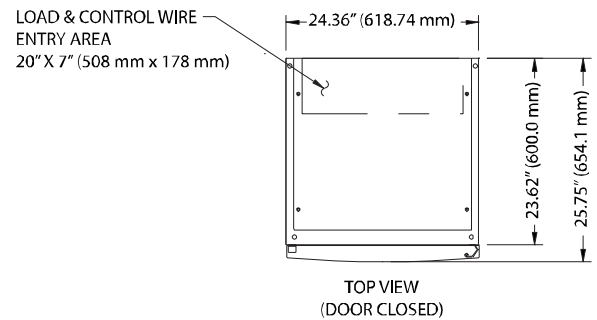

Figure 1 – C21/EC21 Dimmer Rack Fully Populated

---

## Dimmer Modules

The power modules are the high power switching section of the C21/EC21 dimming system. The power block in this module is the interface between the high power AC and low power control. It is driven by low level signals (5mA, 3-24V) and switches high level signals (up to 100A, 120/240VAC). High specification filtering, SCR dimming, contactor non-dims, IGBT dimming, and load status reporting electronics are available as options. Dimmers can be mixed in any combination in a rack. This lets you use the exact dimmer type needed for each circuit.

Power modules are constructed from aluminum, folded to form three sides of the dimmer and to support the dimmer connector and heatsink. The fourth side of the dimmer is formed by the heatsink. The top and bottom of the dimmer are open for cooling.

A sturdy handle is provided below the circuit breakers. An optional mechanical locking bar on the dimmer tray secures the dimmers in the rack.

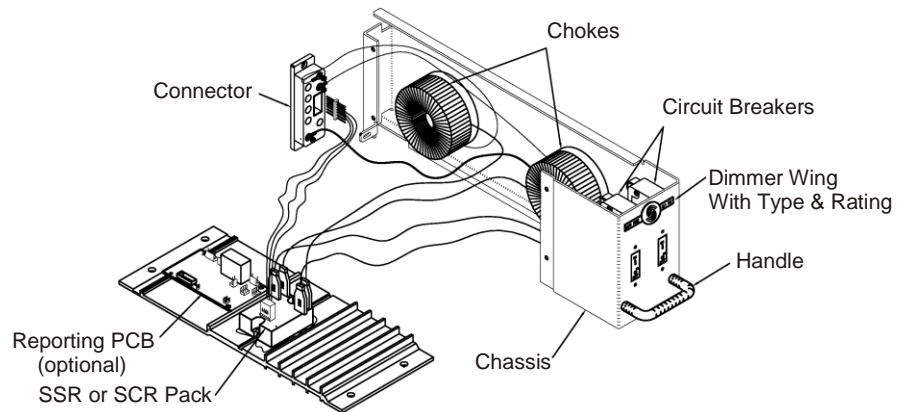

Figure 2 – Dual Dimmer Module

### Reporting Dimmer Modules

Most C21/EC21 dimmer modules are available in load status reporting versions. Load status reporting versions of dimmers can be mixed in any combination with standard dimmers in C21/EC21 racks. These dimmers report many dimmer status items back to the processor. The information can be accessed through various menu items. The processor can then display a wide range of faults and diagnostic data.

Each Reporting dimmer module contains a temperature sensor which will shut it down if it overheats. Anything causing overheating in the rack will cause a gradual shutdown as each Reporting dimmer module overheats.

---

## IGBT Dimmer Modules

C21/EC21 IGBT electronic dimmers provide users with exceptionally quiet and efficient dimming for a wide range of loads. Each IGBT dimmer features forward and reverse phase control operating modes suitable for dimming incandescent and low voltage loads as well as a broad range of LED loads.

All C21 IGBT dimmers offer low insertion loss and microprocessor controlled over current and short circuit protection. Resetting the dimmer to zero percent (0%) from the control system will restore operation in the event of a module shutdown.



Warning

**Make sure that the neutral wire is landed correctly with its corresponding load wire for proper operation (see the C21 or EC21 Installation manual for more information). Failure to do so will cause the dimmer module to shut down.**

**Since the IGBT dimmer module monitors the dimmer rack power feed at all times, it is imperative that the power feed is clean and free of any distortion.**

**In the presence of poor quality power with significant mains disturbances, the IGBT dimmer module may shut down to protect the IGBT power devices.**

**IGBT dimmer modules should be configured as "Sinewave" module types when configuring the C21/EC21 dimmer rack processor.**

## IGBT Dimmer Module Switch Pack

The DIP Switches located at the side of the IGBT dimmer module allow for configuration of dimmer options. *Note - dual-channel modules have a separate switch pack for each channel.*

**CONTROL MODE** - (Factory Default ON) (Factory Default: Force FPC) Dimmer racks must be operated under normal conditions with all dimmers configured to Force FPC. If directed by Strand Technical Support, changing this switch to the AUTO mode position will allow the dimmer to automatically sense the load type and select either Reverse Phase Control or Forward Phase Control, based on the load's behavior. AUTO mode should be used only when a load does not operate properly in the default Force FPC mode.

**RPC LOCK (LED)** - (Factory Default: Normal) When used in combination with CONTROL MODE = AUTO, setting this switch to the Force RPC position locks the dimmer into reverse-phase-control only operation, which may be required for certain LED loads. Always set this switch to Normal in all other cases.

**TRANSITION CONTROL** - (Factory Default Automatic) Automatic operation allows the IGBT dimmer to monitor and adjust its transition control (up to 1000uS in 120V installations, and up to 650uS in 230V installations) based on several operational factors. The "Fixed at 400uS" position should ALWAYS be used when the dimmer is operating a phase-controlled electronic ballast or LED driver as its load, because these devices expect fixed transition times for proper dimming level selection.

**FULL OUTPUT VOLTAGE** - (Factory Default: 120V / 240V) These switches select the RMS output voltage to be delivered by the dimmer when the control level is 100%. Choose a non-default value if lamps of a lower voltage rating (e.g., 115V on 120V) are used in the lighting rig.

**PREHEAT** - (Factory Default: Preheat Disabled) When changed to the non-default position (Preheat Enabled), the dimmer will generate a very low voltage to the loads, when they are "off", to keep the filaments heated, improving response time. This feature should only be enabled on larger-wattage, incandescent lamps and only when faster turn-on response is required.



**CAUTION:** It is never recommended to set the switches to Reverse Phase Control (RPC) for an entire rack of IGBT modules.

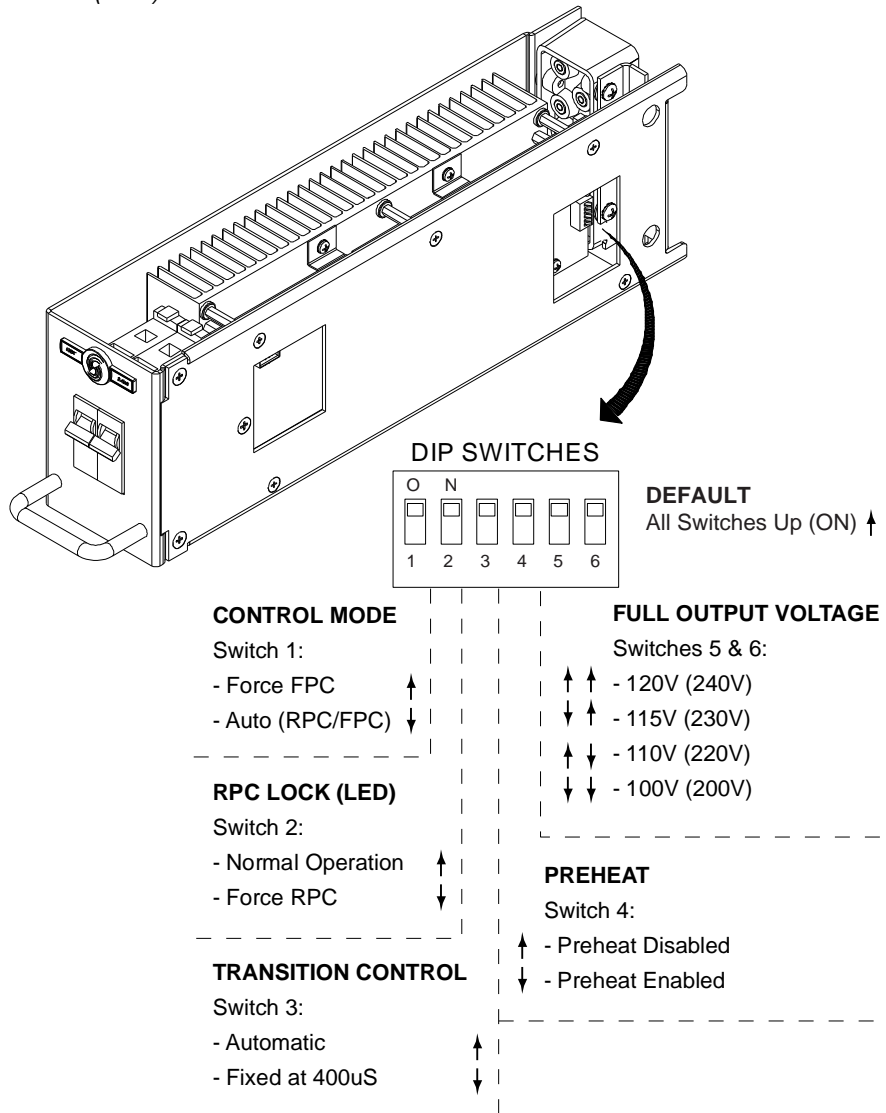

Figure 3 – DIP Switch Settings

**Fan Module**

C21/EC21 dimmer racks are cooled by one or two low-noise variable speed fans in a fan module inside the rack. The cooling system is designed to let the rack continue functioning if any one of the fans fail. Cooling air is pulled up through the dimmer stack and exhausted through venting at the top of the rack. These fans are for dimmer cooling only, and can be set to fixed or variable speeds.

The fixed speed fan setting is for situations where changes in ambient noise are a problem. With this setting, the fans are always ON when the dimmer rack is in operation.

The variable speed fan setting minimizes noise and maximizes fan life. With this setting, the fan speed is adjusted so that fans reach full when 24 dimmers are at full, or equivalent (e.g., 48 dimmers at 50%). Increases in fan speed take 1 minute with this setting, while decreases in fan speed take 5 minutes. Fans are turned OFF when no dimmers are in use.

Fan and dimmer module choke noise may be acoustically objectionable. C21/EC21 dimmer racks should be installed away from performance, stage and audience areas.

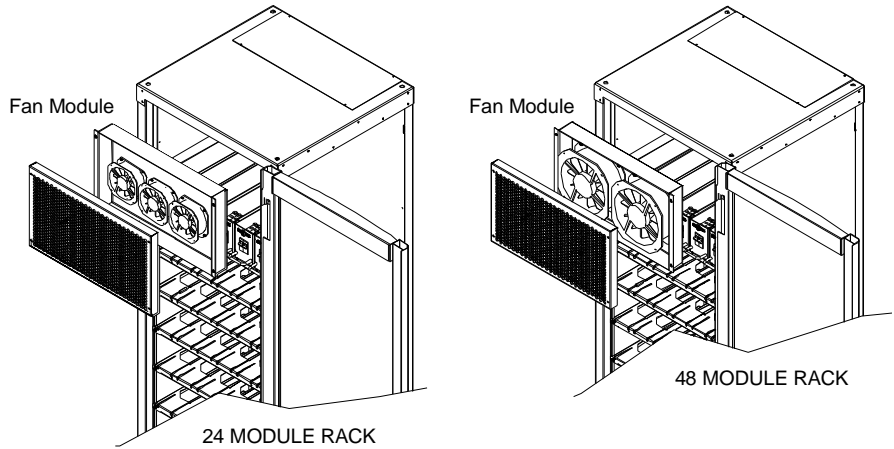

Figure 4 – Fan Module

**Rack Processor Housing**

Each C21/EC21 dimmer rack contains a rack processor housing (RPH) with all of the control electronics for the rack. This RPH contains the processor module(s) (RPM), control station power supplies, and control interconnection card (CIC) for the rack, and is shipped separately from the rack to minimize the possibility of damage.

This chassis can be equipped with one or two processor modules. The second processor module acts as a backup. The configuration data from either processor can be transferred into the other processor. The currently inactive processor always tracks the currently active processor.

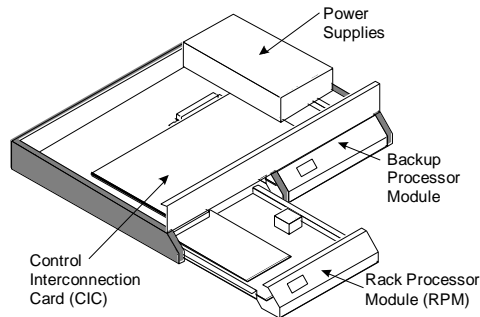

Figure 5 – Rack Processor Housing

**Rack Processor Module**

Each C21/EC21 dimmer rack contains one or two rack processor modules (RPM). Each processor module has a backlit LCD display, a 7 key keypad, and 6 LEDs to report processor module and dimmer status and allow setup and control at the rack. In normal operation, this display normally shows the rack name and the OK message. If there are any rack or dimmer events reported, the display will show error messages.



---

Pressing the < or > keys will take you into a series of setup menus to view and set up the more frequently used C21/EC21 features. See Section 3, *Processor Module Programming* for details on accessing these functions.

All programmed data is held in battery maintained RAM for up to 6 months without power.

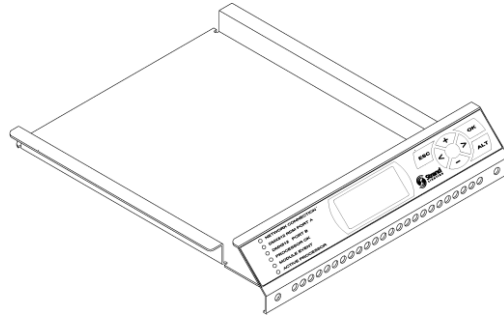

Figure 6 – Rack Processor Module

**Power Supplies**

Each C21/EC21 dimmer rack can have up to three power supplies, depending on the accessories provided. These power supplies are mounted on the rack processor housing.

**Control Interconnection Card (CIC)**

The electronics chassis also contains the control interconnection card (CIC). This is where the contractor terminates all control wiring for the rack. All control terminal strips are 2-part plug-in strips so that the electronics chassis can be easily removed from the rack.

**Processor Configuration**

Once you have applied power you need to make sure that the system is working correctly and the processor modules are set properly for the installation. This step checks for any problems due to shipping or installation.

**Startup**

When the rack is switched ON, a number of self-tests are run. The system displays the rack name.

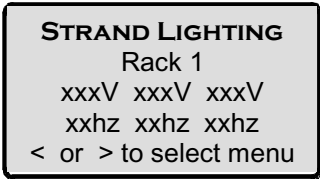

When the self-tests are complete the PROCESSOR OK LED on the front of the processor module will turn ON, and the default text will show on the LCD display.

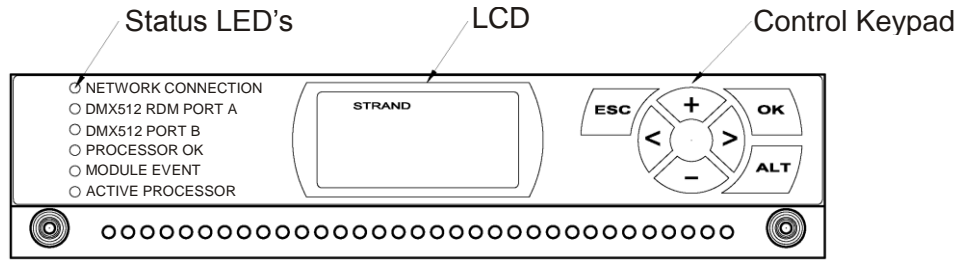

Figure 7 - Processor Module Front Panel

**Note:** If the MODULE EVENT LED is ON, check the dimmer event log to see which dimmer is causing problems. If any other LED does not illuminate correctly, switch OFF the power immediately and check the installation again. If all wiring seems correct, call Vari-Lite or your local Authorized Service Center.

### LED Status

The LEDs on the front of each rack processor module are the first level of diagnostics and provide immediate visual status indication. The nine LEDs on the front of the rack processor housing and module indicate the following:

#### Rack Processor Housing LEDs

Phase A (green):	Should be ON if PhaseA/Line1 is OK.
Phase B (green):	Should be ON if Phase B/Line 2 is OK.
Phase C (green):	Should be ON if PhaseC/Line 3 is OK.
Over-Temp (red):	Should be OFF. Flashing indicates an Over-Temp condition. ON indicates dimmer module automatic Over-Temp shutdown.
Panic (red):	Should be OFF. On indicates that PANIC has Been activated.
Lighthouse (blue):	Blue = normal. Flashing red = error. Solid red = shutdown.

#### Rack Processor Module LEDs

Network Connection (green):	Should be ON if there is a network signal.
DMX512 A (green):	Should be ON if there is a DMX512 signal.
DMX512 B (green):	Should be ON if there is a DMX512 signal.
Module Event (red):	Should be OFF. On indicates a dimmer fault
Processor OK (green):	Should be ON. Off indicates there is a problem.
Active Processor (green):	Should be ON if self-test is OK. Indicates active processor.

### Dimmer Events

If the Module Event LED is on, the LCD will show the number of dimmer events at which time the display can be manually accessed to show a description of the event(s). Refer to the appendices section of this manual for a description of event codes. If any other LED does not illuminate correctly, switch OFF the power immediately and check the installation again. If the fault persists and all wiring seems correct, call Vari-Lite or your local Authorized Service Center ([www.vari-lite.com](http://www.vari-lite.com)).

### After Startup

1. Check the following items to make sure they are correctly set in the processor module:

- 
- Rack type (see *Rack Config Menu* in section 3, *Front Panel Programming*)
  - Phasing (see *Rack Config Menu* in section 3, *Front Panel Programming*)
  - Starting multiplex signal number and dimmer protocol (see *Patching Menu* in section 3, *Front Panel Programming*)
  - Input Voltage (see *Rack Config Menu* in section 3, *Front Panel Programming*)
  - Dimmer numbering (see *Rack Config Menu* in section 3, *Front Panel Programming*)

Other items you may wish to check at this time, depending on your system configuration, are:

- Mux patch (see *Patching Menu* in section 3, *Front Panel Programming*)
  - Outlook patch (see *Patching Menu* in section 3, *Front Panel Programming*)
  - Max Voltage (see *Rack Config Menu* in section 3, *Front Panel Programming*)
  - Min Level (see *Rack Config Menu* in section 3, *Front Panel Programming*)
2. Switch on all load circuit breakers.
  3. Connect a suitable luminaire to each outlet and check every dimmer using the SET LEVEL control facility, a suitable control console, or an SWC hand held controller. Investigate and correct any malfunctions you find.

**Note:** *If any dimmers do not work, stop and check the slot type for the dimmer. Dimmers will not work properly if their slot type is incorrectly assigned. Make sure that all of the modules are in their correct slots, and that the slot type for each dimmer is correctly set in the processor module.*

4. Install the fan grill and door to complete the system installation.

---

## Section 2 - Operational Features

**Rack Configuration** The following configuration items are usually programmed during commissioning, but can also be reprogrammed by the user.

- Rack name.
- Panic selection and configuration.
- Maximum output voltage (per dimmer): 20-250 volts (e.g. set to 105V for extended lamp life).
- Minimum level (per dimmer): 0% - 100% (e.g. set to 10% for aisle lights or large lamp preheat).
- Room and channel Patching.
- Each dimmer can be patched to any valid DMX512 address number for the standard input A (DMX512 A), input B (DMX512 B) or network.
- Circuit ID—used by status reporting software.
- Define Preset Number or “Hold” condition on DMX512 failure.
- Define power-up preset.
- Set LCD contrast.
- Error log accessible from the processor module or status reporting software.
- Individual dimmer reporting enable/disable.

**Dimmer Configuration** Configuration items associated with the dimmer module can be set from the processor module front panel.

- The output response profile can be set to Linear, Square, S-Curve, Fluo-Electric (for electronic fluorescent ballasts), Fluo-Magnetic (for magnetic fluorescent ballasts), and Non-Dim. The two fluorescent settings let you set the top end voltage and the bottom end cutoff voltage. The Non-Dim setting lets you set the turn-on threshold for the non-dim. Five additional user programmable profiles are available through the *Set Rack Configuration* menu or from the optional status reporting software.
- Dimmer response (per dimmer): fast (30ms), normal (100ms), slow (300ms), very slow (700ms) or Glacial (1000ms). This determines a dimmer’s rate of response to a change in control level. Slow is usually set for large tungsten loads to reduce filament inrush, medium or fast for small loads.
- Dimmer control assignment (per dimmer) to the “combined” levels of Vision.net, DMX512 A, DMX512 B, Network or to a fixed level (0% - 99% or “Full”). The way in which the various input levels combine is also determined on a per dimmer basis by setting the dimmer DMX512 mode.
- A special smoothing algorithm is applied to small level changes to maintain smooth fades with long fade times.

### Control Inputs

The Control Interconnection Card, or CIC, is the printed circuit board on which all contractor control wiring connections are made. It is located on the top of the Rack Processor Housing (RPH) and contains:

- An optional Ethernet switch which connects to a Strand ShowNet system. This switch allows for easy connections between dimmer racks. It also connects to the network receptacle located in the upper left rear of the dimmer rack.
- Two optically isolated DMX512 control inputs. Both inputs can be configured as a DMX512 input, DMX512 output, and Strand Lighting's Vision.net architectural protocol. Each DMX512 input has a patch to allow overlapping or separation of any DMX512 control level.
- Six optically isolated contact inputs, for:

Pin	Function	Type	Description
1	PANIC ON	Momentary	Turns Panic On
2	PANIC OFF	Momentary	Turns Panic Off
3	FIRE ALARM	Maintained	Turns Panic On, No Override
4	SWC PRESET 1	Momentary	Fires SWC Preset 1
5	GO NEXT SWC	Momentary	Fires "Next" SWC Preset
6	GO SWC OFF	Momentary	Fires SWC Preset 0 (Blackout)
7	Com/Gnd		Com/Gnd
8	Com/Gnd		Com/Gnd

- An Audio Visual Interface port. This serial input will support connection to an external A/V or show control system that supports an RS232 serial connection.
- 96 Panic Select switches

## Safety Features

In order to minimize the impact of failures to any part of C21/EC21 dimmer racks, a number of security features, some of which are optional, are provided.

Standard safety features for C21/EC21 dimmer racks include:

- Convection cooling of all components with fan assist.
- Module over-temperature shutdown (Reporter modules only).
- The processor module can be set to hold the last dimmer levels forever, or to fade to a specified preset in cases of DMX512 signal failure.
- Setup data is stored in non-volatile RAM.
- 2500V optical isolation of DMX512 A and DMX512 B inputs, architectural control communication.
- All, or selected dimmers in a rack can be set to either Off or full On when the external Panic button is pressed.
- Automatic Panic on removal of processor module. In racks with two processor modules, both modules must be removed to activate Panic.
- Keypad lock.

---

Optional safety features for C21/EC21 dimmer racks include:

- Redundant tracking backup (requires a second processor module fitted to the rack). The backup processor automatically tracks the master processor and takes over control of the dimmer rack on failure of the master processor.

## **Vision.net**

Vision.net is a comprehensive family of control stations designed for architectural applications needing a simple, flexible control solution with minimal installation and cabling costs. These control stations can access, modify, and recall lighting levels stored in the rack processor module. Vision.net control station features and options include:

- Control up to 255 separate rooms, with up to 125 channels per room
- 32 preset scenes available for each room
- Manual sliders (3, 6, 9, or 15 sliders per station) for direct control of individual circuits
- Record facility for saving slider levels for future push-button recall
- Programmable fade times between 0 and 60 minutes from Vision.net control stations
- Record lockout facility for playback-only operation
- Preset stations available from 1-button up to 8-buttons
- Audio-visual interface
- Room combine stations for room partitioning
- Photo sensor and motion sensor

---

## Section 3 - Programming the C21/EC21 Dimmer Rack

**Controls and Displays** You can access the range of C21/EC21 dimmer rack programmable features using the Rack Processor Module keypad and 21 character, 8 line display. Menus are shown in English.

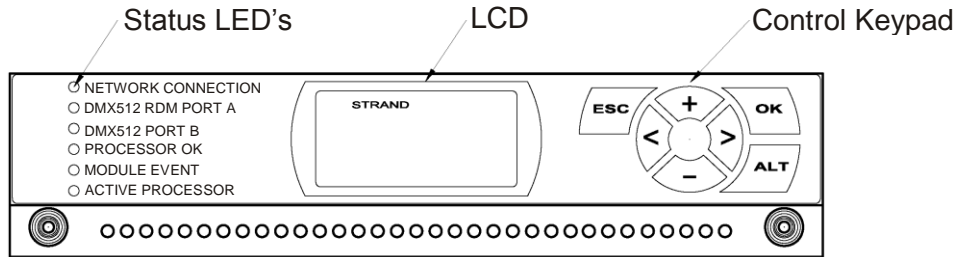

Figure 8 - Rack Processor Module Front Panel

The control buttons let you scan through the various menus and options and set the programmable features of the C21/EC21 dimmer rack.

**Key Lock** To avoid accidental or unauthorized use of the keys, you can lock the keypad. When the Key Lock option is enabled, the processor keys are locked automatically after 10 minutes with no keyboard input. When disabled, the keys are unlocked. The factory default setting for this option is disabled. When locked, a key symbol is displayed on the lower-right side of the default display.

### To temporarily unlock the keys

Press and hold **[ESC]** and **[OK]** simultaneously for at least 2 seconds. Unless the Set Processor Key Lock option is disabled, the keys will again lock after 10 minutes of no key activity.

## Using the Menu Keypad

---

The default display appears if no keys are pressed for 10 minutes, unless one or more error conditions have occurred. If more than one error has occurred, they are displayed continuously in sequence.

Press **[+]** or **[-]** to cycle through the status menu, which shows a summary of the main rack statistics.

In general the rack processor keys do the following:

**[<]** Moves to the next menu or moves the cursor to the next digit of a field.

**[>]** Moves to the next menu or moves the cursor to the next digit of a field.

**[+]** Increases the value of a digit or field.

**[-]** Decreases the value of a digit or field.

**[OK]** Selects a menu or sub-menu. It is also pressed to accept changes when fields are edited.

**[ESC]** Returns the display to the previous menu level. Most configuration changes will not take effect until the escape button has been pressed.

**[ALT] + [<]** or **[ALT] + [>]** Selects a character group: numbers, capitol letters or lower-case letters.

If the **[ALT] + [<]** keys are pressed while editing a text field, the text will return to the previous unedited text.

**Note:** The blank "space" symbol is located under the numbers character group.

**[ALT] + [+]** or **[ALT] + [-]** Sets the maximum value for a field.

## The Status Log

The Status Log lets you quickly check the status of the rack, using the **[+]** or **[-]** keys to display each parameter in turn.

If one or more error conditions occur, the status display automatically shows the Error Log, if a Dimmer Event occurs, the Event Log is automatically displayed, Multiple errors or events are auto-scrolled.

The Status log for each rack, lists the rack number and software version number, together with the error code and description of the error.

**Note:** When the backup and main processor are functioning, both displays should show "Tracking." When the system is properly tracking, data is continuously copied from the "Enabled" processor (Master) to the "Disabled" processor (Backup). Phase current will always be 0 (zero) on the backup processor.

The Status Log will return to the default display 5 seconds after the last key press.



## The Main Menu

The main menu lets you access all the other menus for configuring C21/EC21 dimmer racks.

### To access the main menu

From any of the status displays, Press [**<**] or [**>**]

### To return to the main menu

Press [**ESC**]

**Note:** If no dimmer event is registered, returning from the main menu brings you back to the display from which you called the main menu. If a dimmer event is registered you will return to the dimmer events display.

## Rack Identity Menu

The Rack Identity menu allows you to configure the following settings for the dimmer rack:

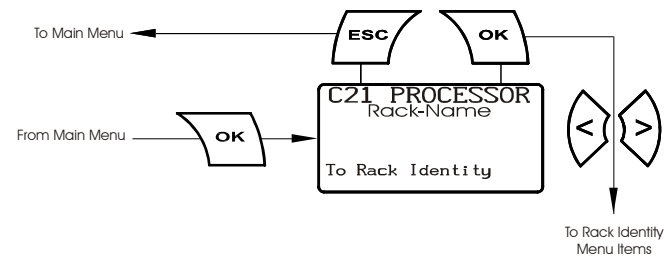

### Set Rack Name

View or edit the name of the dimmer rack in this text field. The rack name is displayed on the second line of the display.

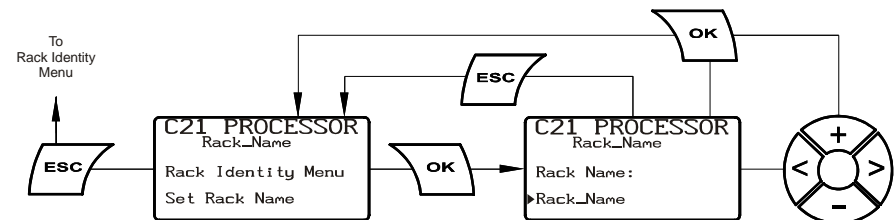

### Set Rack Location

View or edit the location of the dimmer rack in this text field.

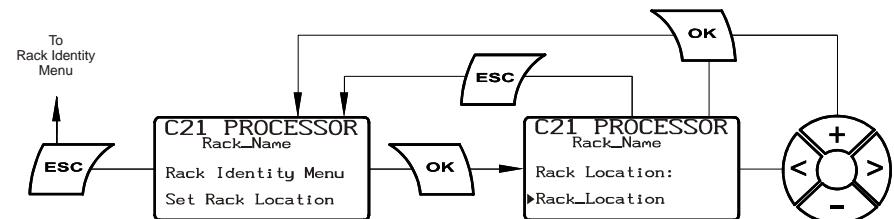

### Set Main Breaker ID

View or edit the name or location of the main breaker in this text field.

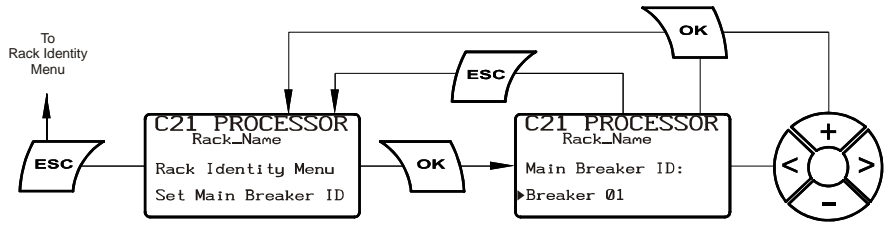

### View Serial Number

Allows you to view the C21/EC21 Processor serial number. The serial number is entered by the factory and should not be changed in the field.

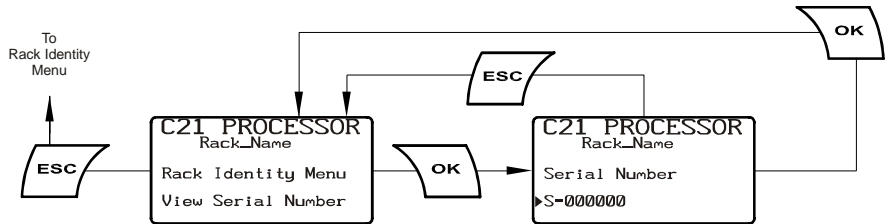

### View Dealer Info.

Allows you to view the *Dealer Information* text field. The information for this text field is entered within the *Factory Menu* section.

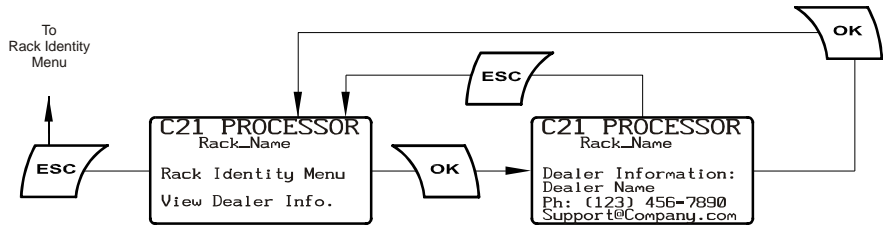

### Set Date

Allows you to view or edit the date field.

Format: MM/DD/YY

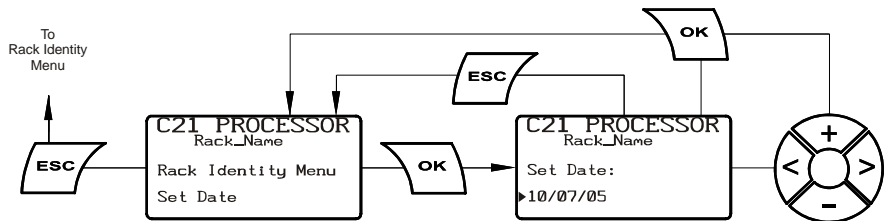

**Set Time** Allows you to view or edit the time field.

Format: 24-hour (HH:MM:SS)

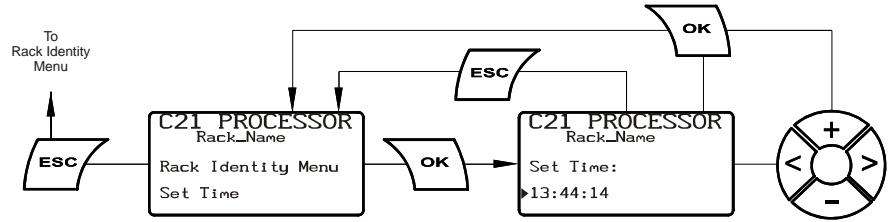

**View Rack Size** Allows you to view the rack size (slot and dimmer count). The rack size is set in the *Factory Menu* section.

Default: 48 slot 96 Dims

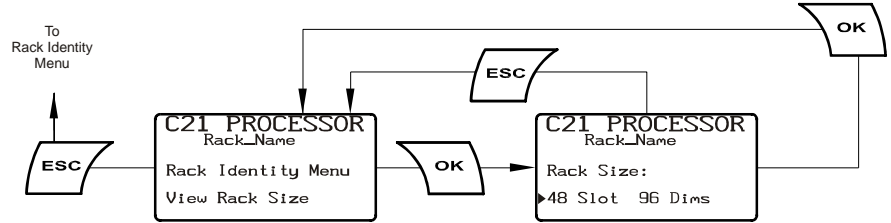

**View Software Version** Allows you to view the current software version of the rack processor.

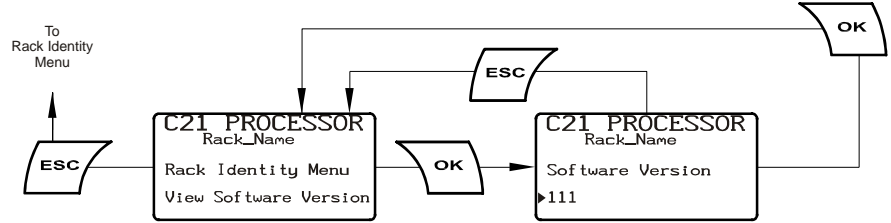

**Set Rack Unique ID** Allows you to set the Rack ID number. The default number is set at the factory and must be changed to reflect the programming of Vision.net rack numbers within Vision.net Designer software.

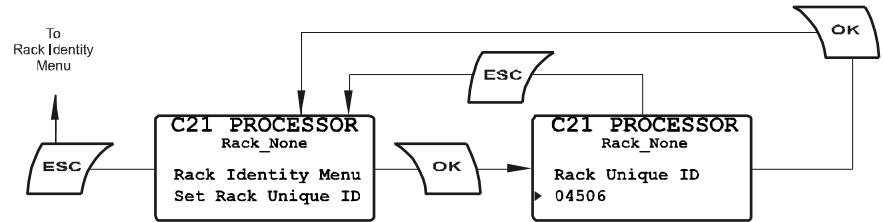

## Network Config Menu

The Network Config menu allows you to configure the following settings for the network settings of the dimmer rack:

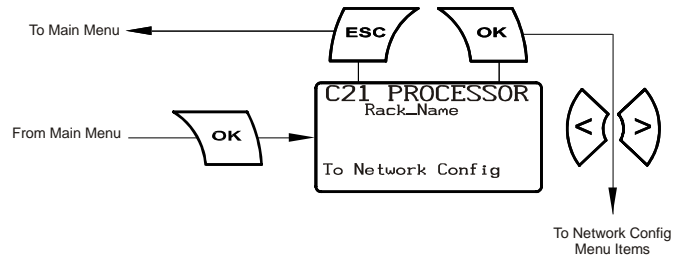

## Set IP Address

Allows you to enter the IP address for the rack processor.

The default IP address is: 192.168.0.72

**Note:** Every rack processor is set to this default IP address. Make sure you create a unique number for each dimmer rack in the system prior to adding the racks to the network.

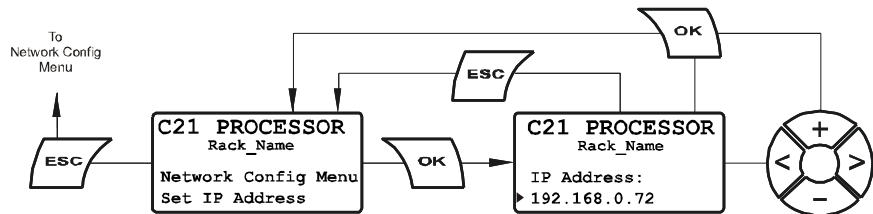

## Set SubNet Mask

Allows you to set the SubNet Mask for the rack processor.

The default SubNet Mask is: 255.255.255.0.

**Note:** The default subnet Mask should not be changed unless instructed to do so by Vari-Lite.

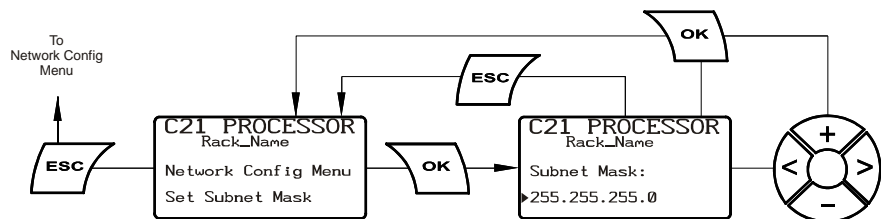

## Set Host Name

Allows you to set the Host Name for the processor.

Enter a unique name for the rack processor in this text field.

**Note:** This field is node name seen on the network and is different than the dimmer rack name created in the Rack Identity Menu.

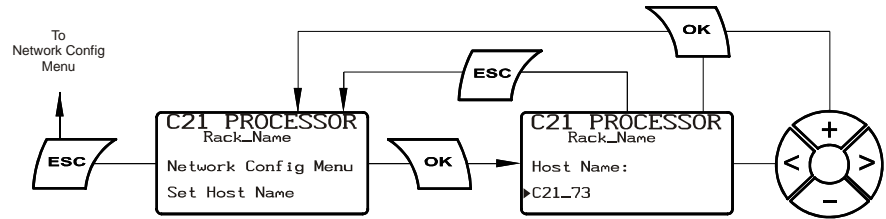

## Set Gateway IP

Allows you to set the Gateway IP address for the processor.

The default Gateway IP is: 0.0.0.0

**Note:** The default Gateway IP address should not be changed unless instructed to do so by Vari-Lite.

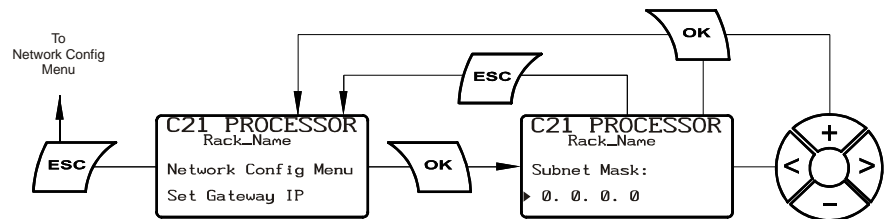

## View MAC Address

Allows you to view the MAC Address assigned to the C21 and EC21 processor. The MAC address is set at the factory is not accessible.

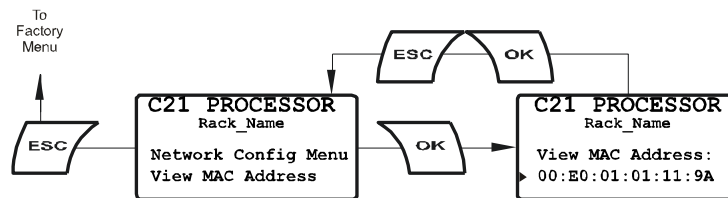

**Rack Config Menu** Rack Config Menu allows you to set the configuration of the dimmer rack.

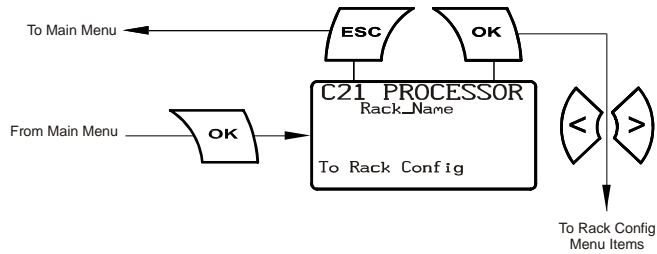

**Review Module Types** Allows you to review the dimmer module type (00 through 99) assigned to the dimmer slots, 6 dimmers at a time.

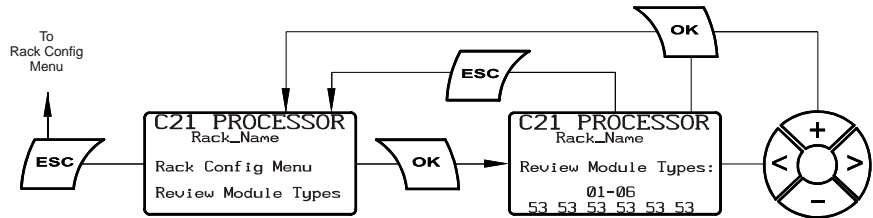

**Set Module Type** Allows you to set a single dimmer module type (based on the module part number) for each rack slot.

See Section 1 to view a list of the dimmer module types for the 120v and 230v markets.

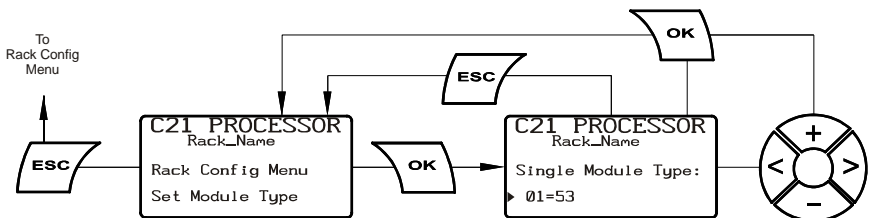

**Set Module Type Range** Allows you to set the module type (based on the module part number) for a range of dimmer rack slots.

See Section 1 to view a list of the dimmer module types for the 120v and 230v markets.

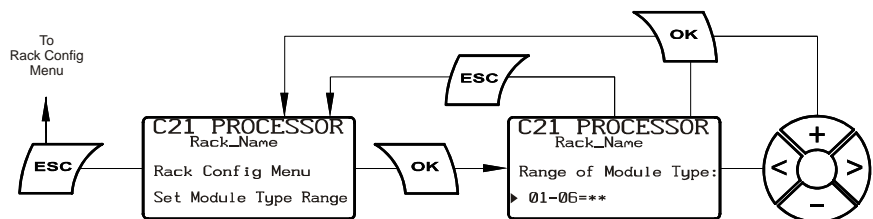

**Set Fan Control** Allows you to adjust the minimum fan speed.

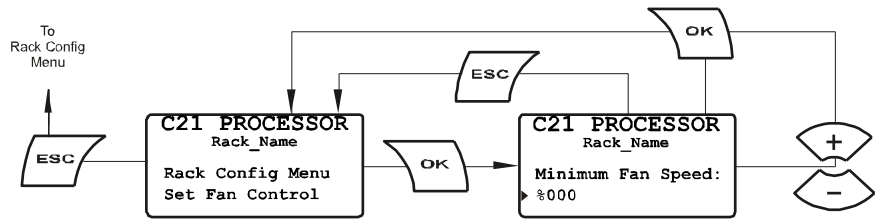

**Set LCD Backlight** Allows you to view or edit the LCD backlight.

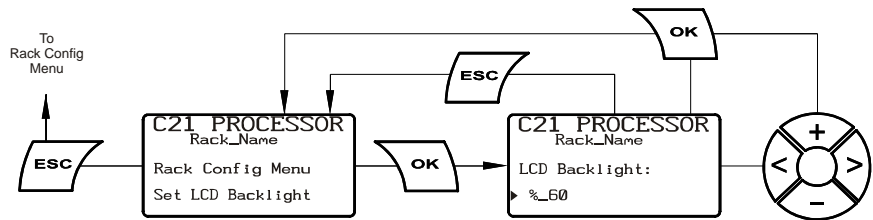

**Set LCD Contrast** Allows you to view or edit the LCD Contrast.

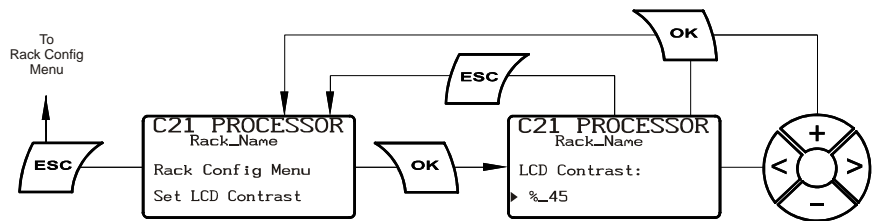

**Set Keypad Lock** Allows you to enable or disable to keypad lockout.

The C21 processor incorporates a safety system to lock out the processor keys to prevent tampering by unauthorized personnel. When the keys are locked, a key symbol is displayed on the right-hand side of the LCD on the default display only. Under this condition, the keys are inoperable unless you press the [ESC] and [OK] keys simultaneously, and hold them for about two seconds to release the lock. When enabled, the key lock will automatically lock the keys if no keys are pressed for a period of ten minutes.

When disabled, the keys are always unlocked.

When set to enabled, keys are not locked and the key lock symbol is not displayed on the default display until ten minutes after the last key is pressed.

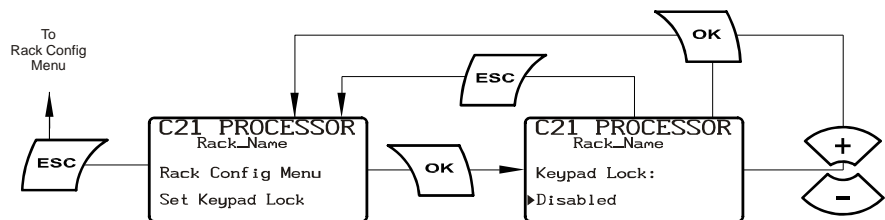

**Set Active Processor**

Allows you to select which processor, main or backup, will be active.

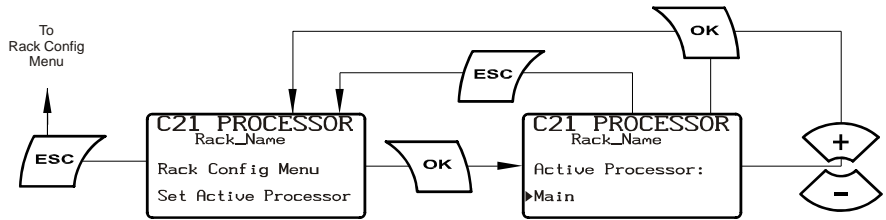

**Enable Cable Comp.**

Allows you to enable or disable cable compensation.

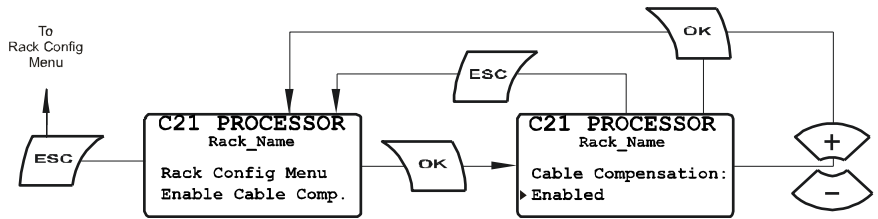

**Enable VoltLoss Comp.**

Allows you to enable or disable voltage loss compensation.

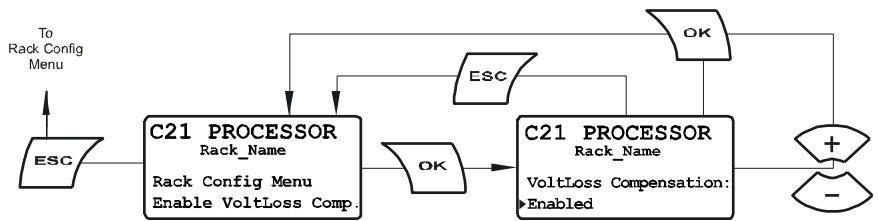

**Save Recovery Config**

Allows you to save the current processor configuration as a recovery file on the Control Interconnection Card (CIC) or to the flash RAM.

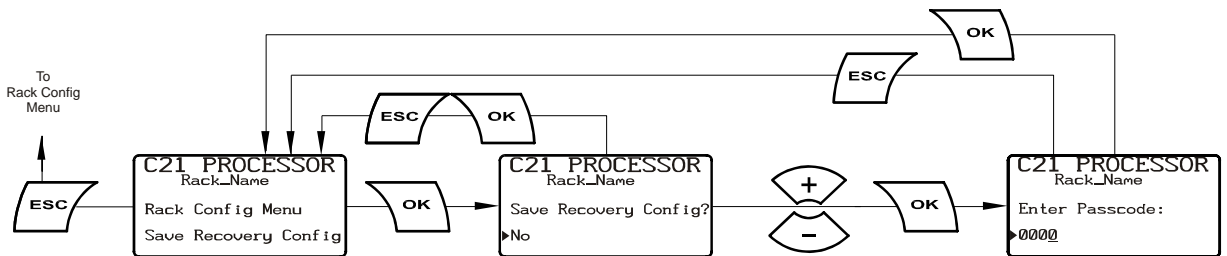



**Restore Saved Config**

Allows you to restore the saved configuration file from the Control Interconnection Card (CIC) or from the flash RAM .

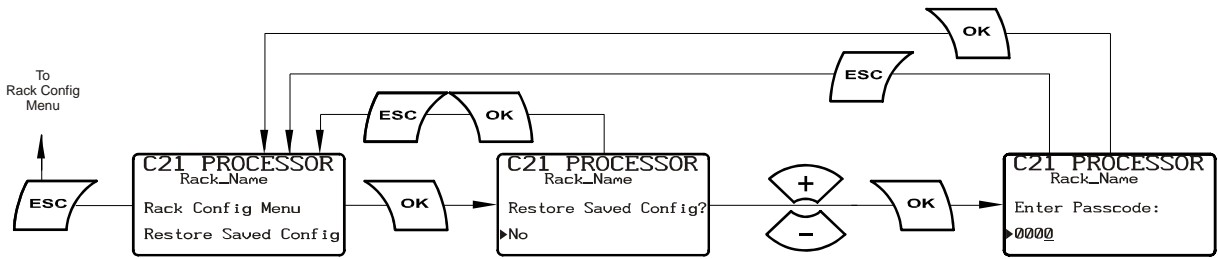

**Change Pass Code**

Allows you to create a 4-digit pass code for secured menu items.

*Note: The Default pass code of '2606' is always enabled and cannot be changed.*

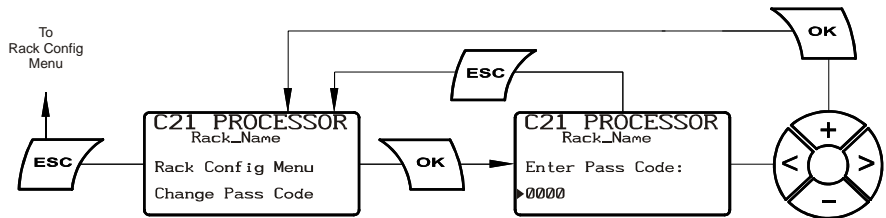

**User Profile Menu**

User Profile Menu allows you to view and create the five user-defined dimming curves.

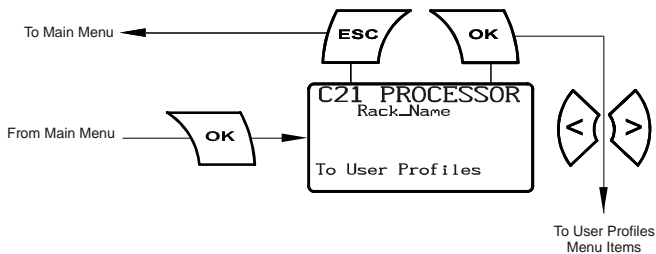

**Set User Profile**

Allows you to view or edit five user-defined dimmer profiles (dimming curves) that may be applied using the *Select Profiles* function under the *Dimmer Config* menu. You can set the input and output values for up to 100 steps for each user profile.

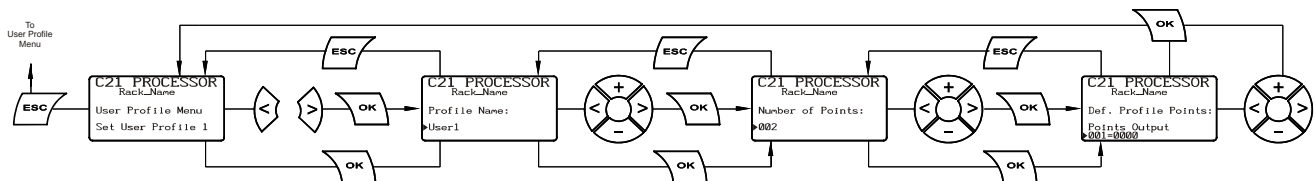

## Dimmer Config Menu

Dimmer Config Menu allows you to set the configuration the dimmer modules and the priority of the discrete signals.

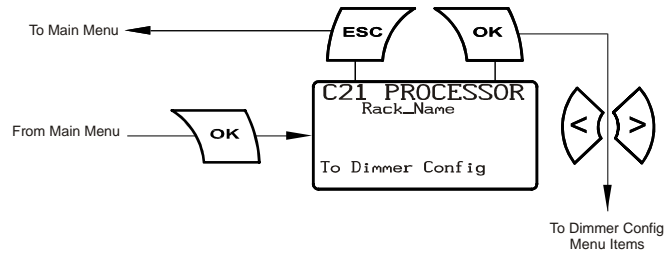

## Set Dimmer Patch

Allows you to assign ranges of dimmers to listen to net-slots at various priority or HTP levels.

Below are the four default patches.

	<u>Dimmers</u>	<u>Nslot</u>	<u>Pri</u>
001	001-96	00001	00h
002	001-96	02001	01h
003	001-96	03001	02h
004	001-96	19001	00
005	*****	*****	***

Column #1	Lists the number of the patch
Column #2 - Dimmers	Lists the range of dimmers assigned to the patch.
Column #3 - Nslot (Netslot)	Lists the start number of the range
Column #4 - Pri (Priority)	Lists the priority number and if it is assigned as HTP

**Note:** By default all possible dimmers are assigned. Generally this number will reflect the actual number of dimmers in the rack.

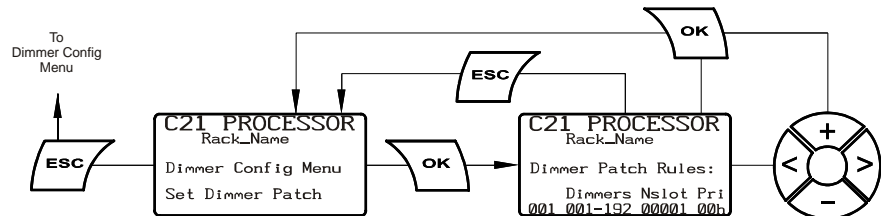

## View Full Output V.

Allows you to view the Maximum output voltage of the dimmers, six at a time.

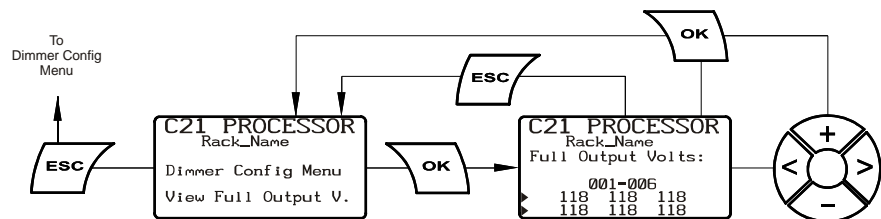

## Set Full Output Volts

Allows you to set the Maximum output voltage for any range of dimmers in the rack. For instance, you can set the maximum voltage lower than the rated voltage of your lamps for improved lamp life. If you have lamps or other equipment which operate at a lower line voltage, you can set the output from the dimmer to an appropriate voltage for the devices.

The maximum output voltage is applied to all dimmers and dimmers assigned as non-dims. It is not applied to contactor non-dims. You cannot use contactor non-dims for devices which need a maximum output voltage setting.

**Note:** This function sets the dimmer output voltage, not the maximum control level applied to the dimmer.

**CAUTION!** Be careful when using a maximum output voltage with dimmers set for PANIC. When panic is activated, full output voltage appears at the output of any dimmer or non-dim set for PANIC, regardless of how the maximum output voltage is set.

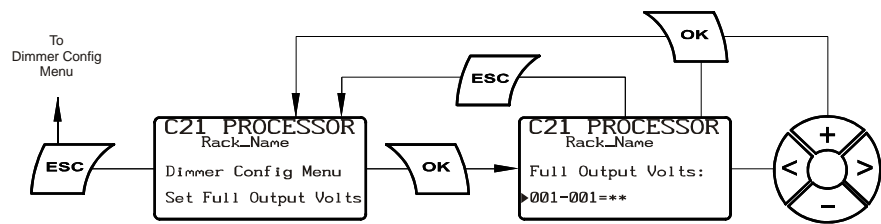

## View Regulation Mode

Allows you to view the dimming curve assigned to a range of dimmers, 6 dimmers at a time.

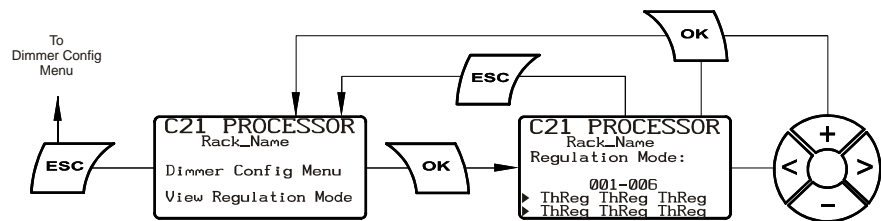

## Set Regulation Mode

Allows you to set the Regulation Mode for a range of dimmers.

These options are:

SiUnr = SineWave unregulated (IGBT dimmers must be configured to this setting)

N-Dim = Non-Dim

ThUnr = Thyristor dimmer unregulated

ThReg = Thyristor dimmer regulated

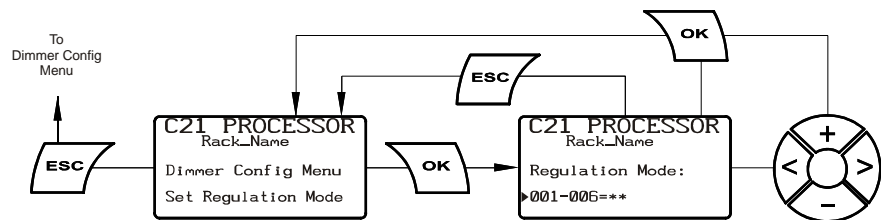

**Set Circuit Names** Allows you to view or edit the Circuit ID number for individual dimmers.

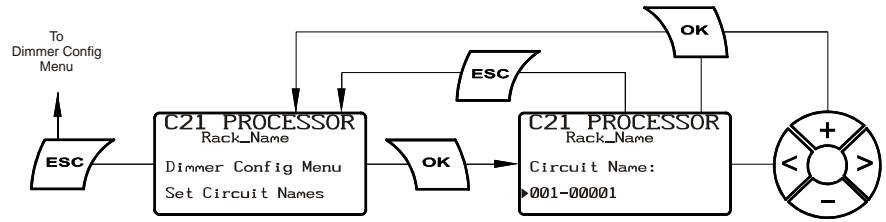

**Autonumber Circuit ID** Allows you to automatically assign sequential circuit ID numbers to the dimmers.

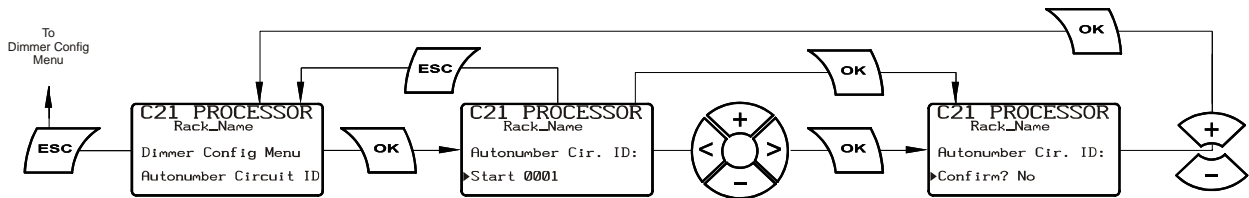

**Load Profile Actions** Allows you to learn and erase load profiles.

- Options are:
- None
  - Erase Load Profile
  - Learn Load Profile
  - Abort Profile Learn

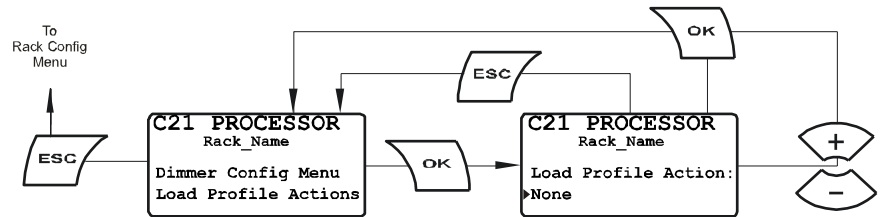

## Dimmer Dynamics Menu

The Dimmer Dynamics Menu allows you to view and configure dimmer information.

### View Response Times

Allows you to view the response times for the dimmers, six dimmers at a time.

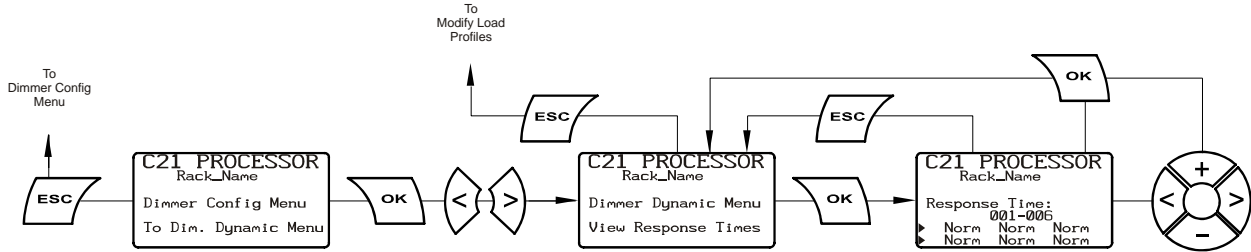

### Set Response Times

The response time of a dimmer is the rate at which it responds to increases or decreases in the control level. C21/EC21 dimmer racks provide five response times:

Fast = 30ms                      Slow= 300ms                      Glacial = 1000ms  
 Normal = 100ms                  Very Slow = 700ms

These options can be applied to a single dimmer or a range of dimmers. Slow is generally used for large lamp loads, while fast is used for smaller lamp loads that might be used in a chase effect.

**Note:** The 'fast' setting, together with the accuracy of digital dimmers can cause very high inrush currents to flow. These may damage large lamp filaments and cause circuit breakers to trip. Only set dimmers to 'fast' if necessary for a particular effect.

**CAUTION!** Do not use 'fast' for IGBT dimmers or lamps that are 5kW or higher.

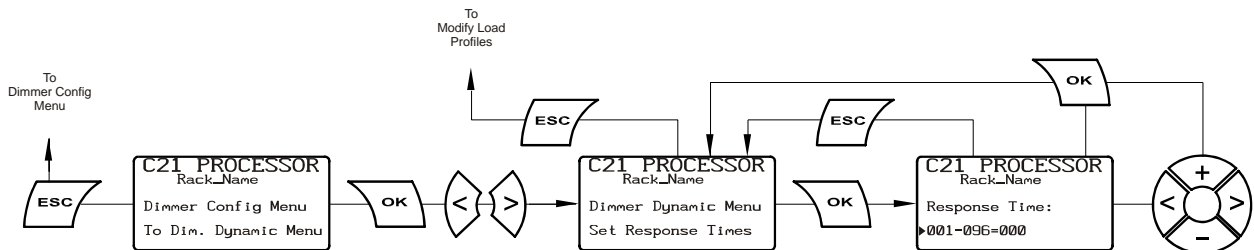

### View Profiles

Allow you to view the dimming curve for the dimmers, six dimmers at a time.

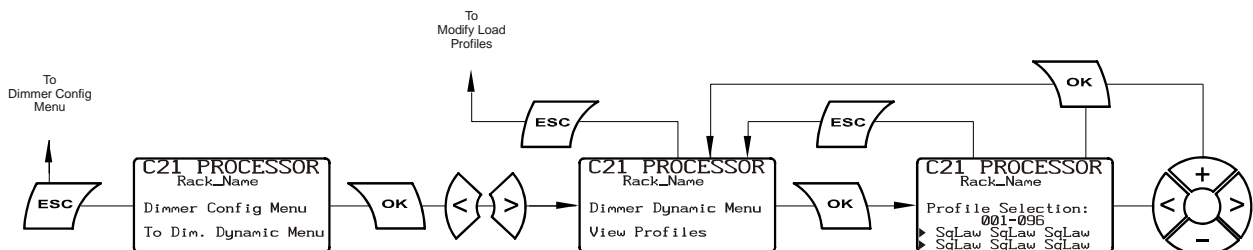

## Select Profiles

Allows you to select the dimming curve for a range of dimmers:

SqLaw = Square Law

S-Crv = S-Curve

LinPw = Linear

N-Dim = Non-Dim

FIEle = Fluorescent Electronic

FIMag = Fluorescent Magnetic

MarkX = Advanced Mark X Ballasts

User1 = User Defined Dimming Curve #1

User2 = User Defined Dimming Curve #2

User3 = User Defined Dimming Curve #3

User4 = User Defined Dimming Curve #4

User5 = User Defined Dimming Curve #5

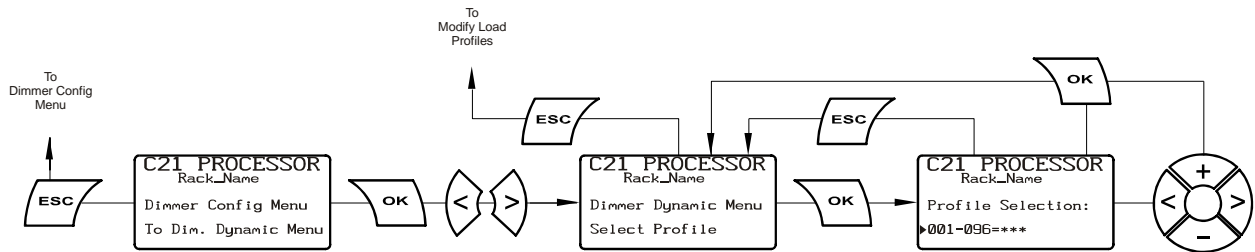

## View Cut Levels

View Cut Levels

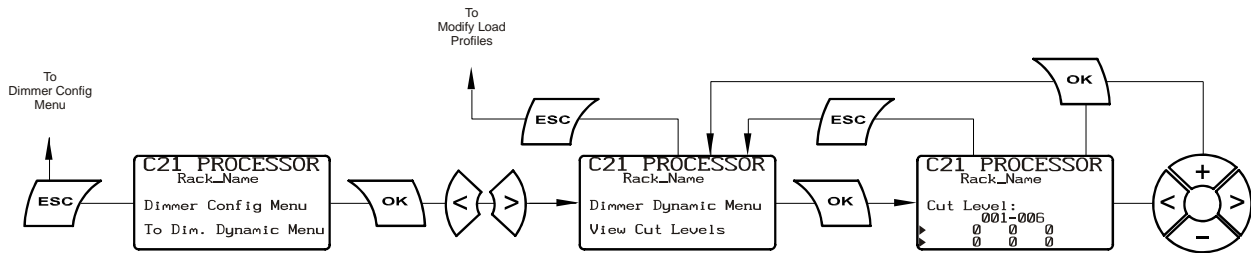

## Set Cut Levels

Set Cut Levels

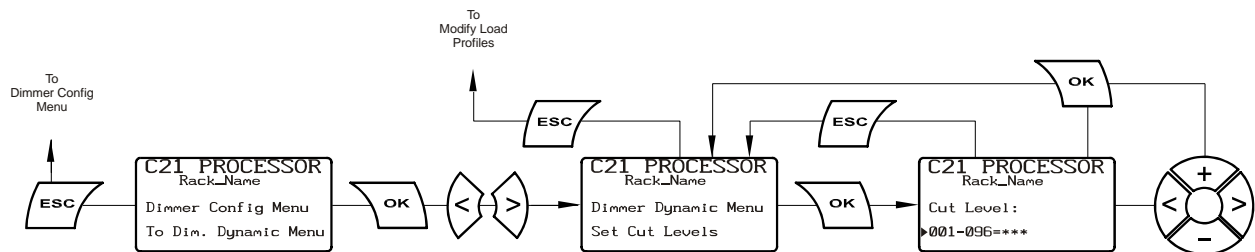

## View Minimum Levels

Allows you to view the minimum dimmer output level, 6 dimmers at a time.

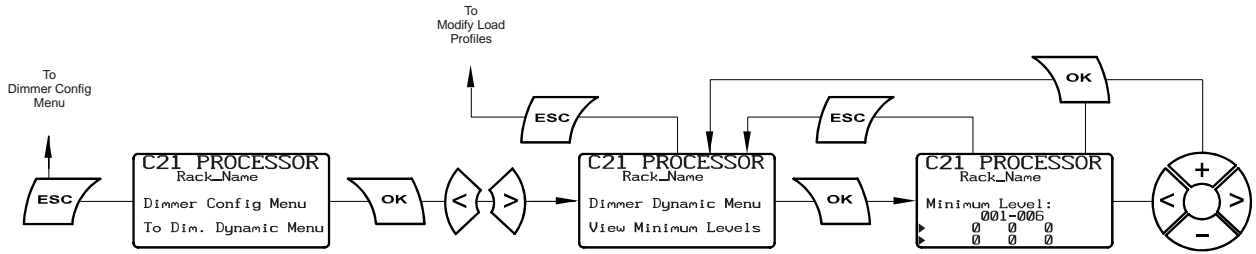

## Set Minimum Levels

Allows you to set the minimum dimmer output level for a range of dimmers.

You can set a minimum level for any or all the dimmers. This can be used for security or safety lighting in locations where a minimum light level is required under all circumstances. This function can also be used as a preheat for large lamps. Minimum levels are displayed in control percentages.

**Note:** This function sets the minimum control level applied to the dimmer, not the minimum output voltage.

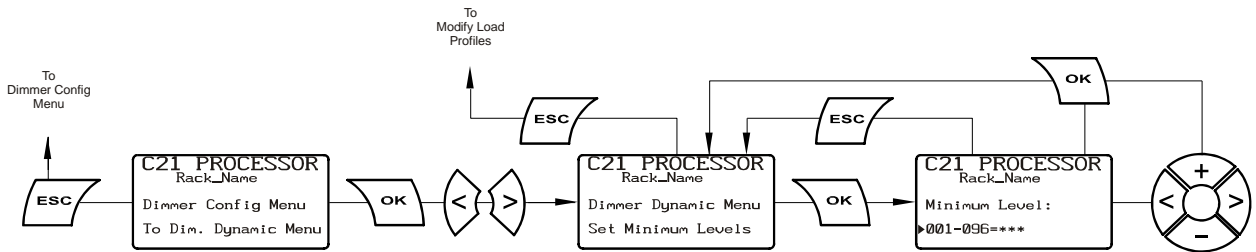

## View Cable Impedance

View Cable Impedance

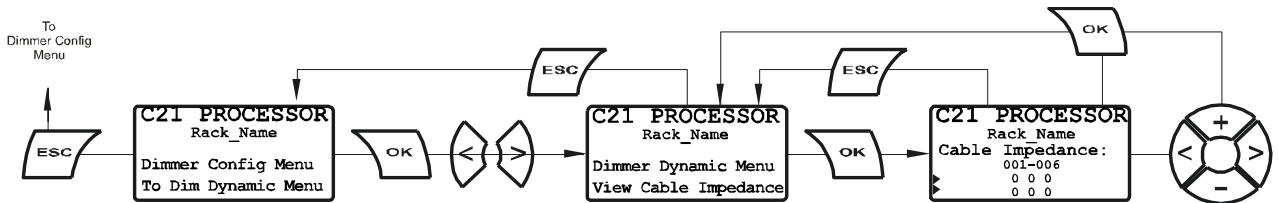

## Set Cable Impedance

Set Cable Impedance

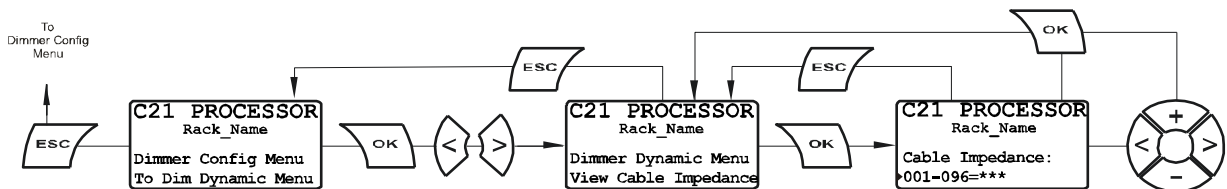

**View Report Enables** View Report Enables

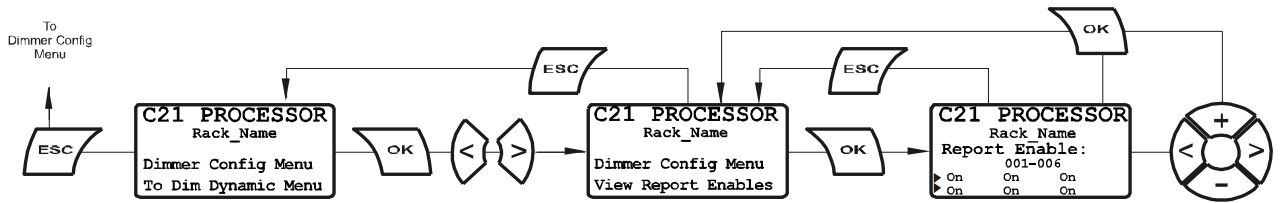

**Set Report Enables** Set Report Enables

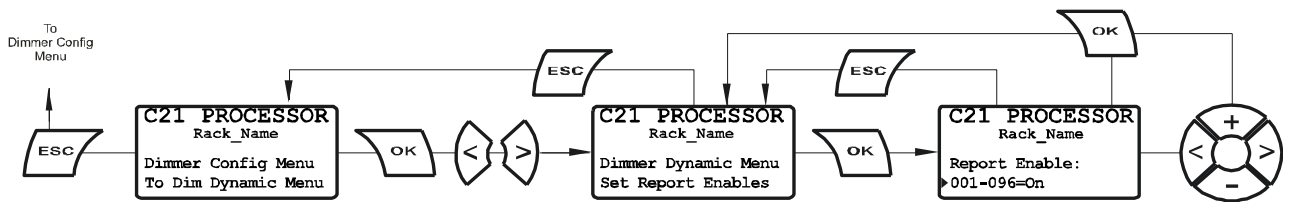

**View Trip Modes** View Trip Modes

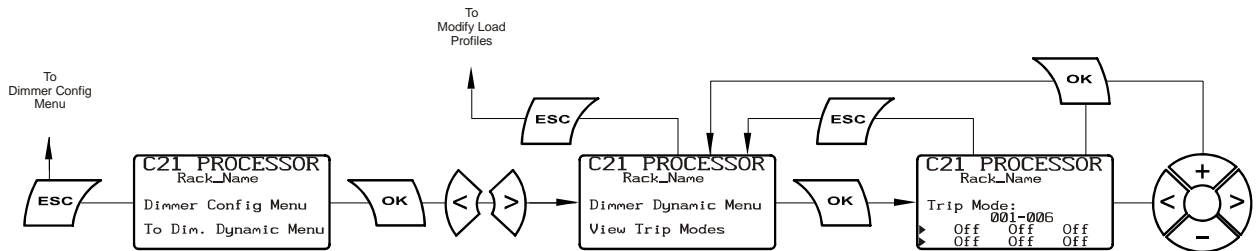

**Set Trip Modes** Set Trip Modes

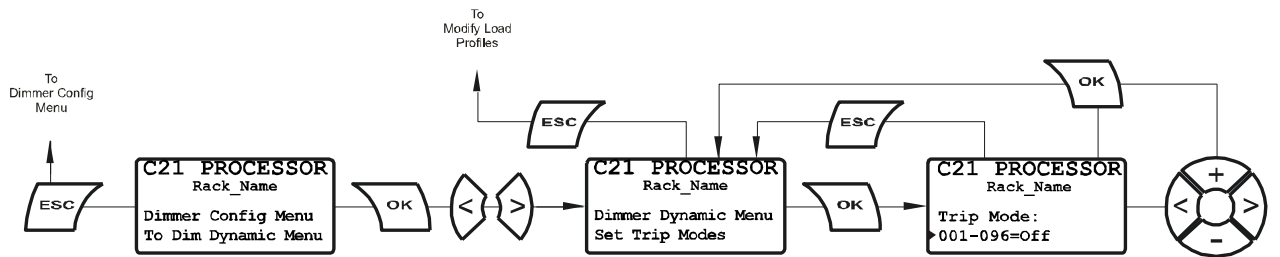



## Input Config Menu

Input Config Menu allows you to view and set the Mux A and Mux B ports.

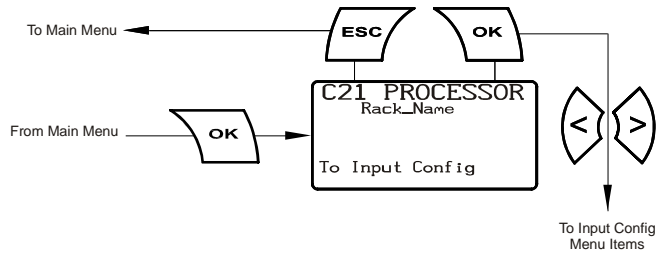

## Set DMX A Options

Allows you to set the DMX512 A port:

Off = Turns the DMX512 A port off

In = Allows you to define the net-slot range for the DMX512 A port.  
(Default: In 001-512 02001)

SMX (Set for Outlook/SWC architectural control stations)

SVN (Set for Vision.net architectural control stations)

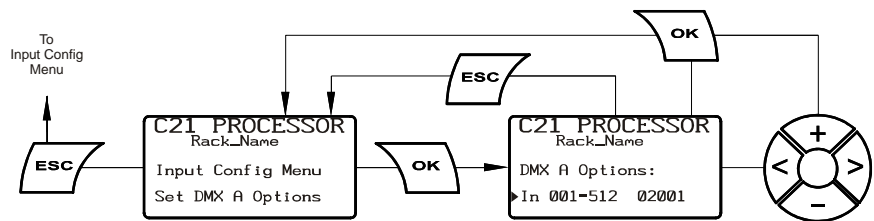

## Set DMX A Label

Allows you to create a label for the DMX512 A port.

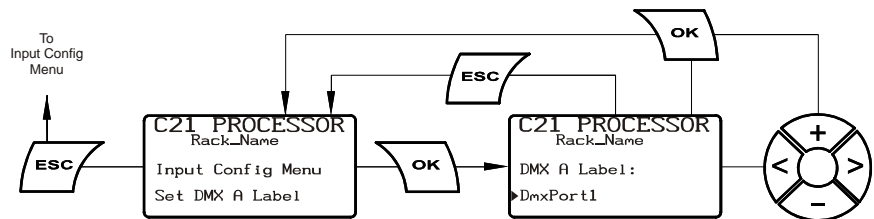

## Set DMX B Options

Allows you to set the DMX512 B port:

Off = Turns the DMX512 B port off

In = Allows you to define the net-slot range for the DMX512 B port.  
(Default: In 001-512 03001)

SMX (Set for Outlook/SWC architectural control stations)

SVN (Set for Vision.net architectural control stations)

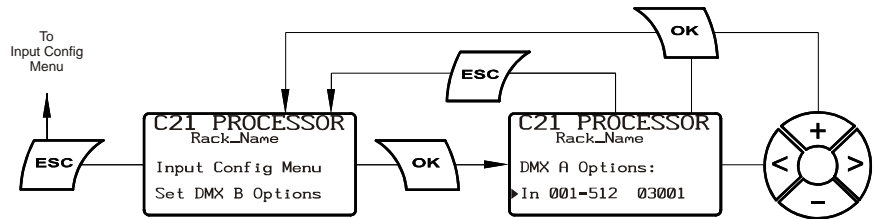

## Set DMX B Label

Allows you to create a label for the DMX512 B port.

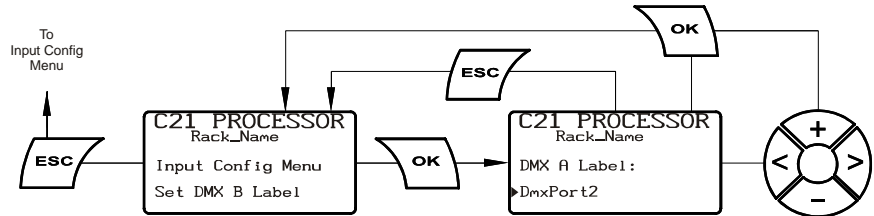

## Set Panic Options

Set Panic Options:

Options: Use Default Setting, On Request, Automatic, Disabled

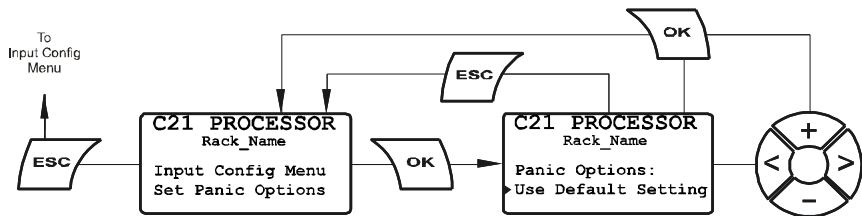

## Enable AV Port

Enables the Serial input port on the CIC board.

Options: Enabled, Disabled

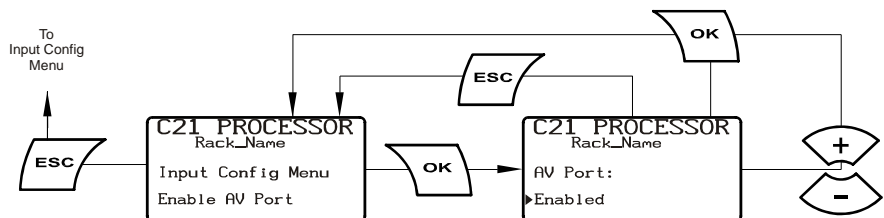

---

Messages are sent from an A/V controller at a maximum rate of 2 Hz (2 messages per second).

**UART Configuration:**

9600 Baud, 8 data bits, No Parity, 1 stop bit

**Message Overview:**

Messages are composed of a short string of printing ASCII characters that request certain actions from the rack processor. Messages are acknowledged by the processor with confirming reply messages or with status update messages. Messages are transmitted as byte streams terminated by designated printing ASCII characters. There is no requirement for line termination. Received characters that do not have a defined function in the protocol are ignored.

**Message Composition:**

Messages are composed of a single command character, followed by an optional numeric field that may be up to 3 characters long, followed by a single terminating character. Thus, complete messages range from 2 to 5 characters long.

Command 1 byte	Parameter 0 to 3 bytes	Terminator 1 byte
-------------------	---------------------------	----------------------

For all messages received from the AV controller, the terminating character is the letter 'Z' in either upper or lower case (0x5A or 0x7A).

For all messages transmitted from the C21 Rack Processor, the terminating character is the letter 'Y' (0x59).

**The following messages are defined:**

**Play SWC Preset:**

Command Code: 'S' or 's' (0x53 or 0x73)

**Parameter:**

Up to three digits indicating an SWC preset number in the range 0..128. '0' represents the "Off" preset.

**Action:**

The rack processor plays back the indicated SWC preset, and responds to the AV controller with the identical message terminated with the 'Y' character instead of 'Z'. If the preset number was out of range, the response message contains "???" instead of the preset requested.

**Record SWC Preset:**

**Command Code:**

'R' or 'r' (0x52 or 0x72)

**Parameter:**

Up to three digits indicating an SWC preset number in the range 1..128. '0' represents the "Off" preset so is not allowed with this command.

**Action:**

The rack processor records the indicated SWC preset, and responds to the AV controller with the identical message terminated with the 'Y' character instead of 'Z'. If the preset number was out of range, the response message contains "???" instead of the preset requested.

---

**Play Outlook Preset:****Command Code:**

'O' or 'o' (0x4F or 0x6F)

**Parameter:**

Up to three digits that represent two numeric fields. The first one or two digits represent the room number. The last digit represents the preset number. The room number may range from 0..15. The preset number may range from 0..9. Preset 9 calls the "Full On" preset.

**Action:**

The rack processor plays back the indicated Outlook preset in the indicated room and responds to the AV controller with the identical message terminated with 'Y' instead of 'Z'. If the room number was out of range, the response message contains "???" in place of the numeric parameter.

**Record Outlook Preset:****Command Code:**

'P' or 'p' (0x50 or 0x70)

**Parameter:**

Up to three digits that represent two numeric fields. The first one or two digits represent the room number. The last digit represents the preset number. The room number may range from 0..15. The preset number may range from 1..8. Presets 0 and 9 are not allowed as these are not recordable.

**Action:**

The rack processor records the indicated Outlook preset in the indicated room and responds to the AV controller with the identical message terminated with 'Y' instead of 'Z'. If the room number or preset number was out of range, the response message contains "???" in place of the numeric parameter.

**Update System Status:****Command Code:**

'U' or 'u' (0x55 or 0x75)

**Parameter:**

None

**Action:**

The rack processor responds by sending 17 response messages as defined above indicating the states of the SWC system and of each room in the Outlook system.

**Examples:**

AV Controller Request	C21 Rack Response
"S001Z"	"S001Y"
SWC preset 1 is now active.	"s123Y"
SWC preset 123 is now active.	"s???Y"
No change in SWC due to out of range parameter.	"o123Y"
No change in Outlook due to out of range parameter.	"UZ"
	"S123Y" "O000Y" "O010Y" "O020Y"
	"O030Y" "O040Y" "O050Y" "O060Y"
	"O070Y" "O080Y" "O090Y" "O100Y"
	"O110Y" "O123Y" "O130Y" "O140Y"
	"O150Y"

**Enable SMX Sharing** Enables SMX Sharing.

Options: Enabled, Disabled

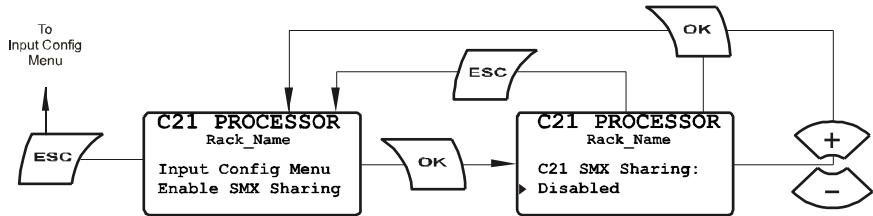

**Set SMX Sharing Group** Sets SMX Sharing group.

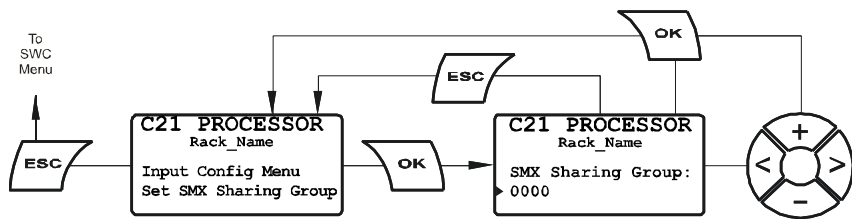

**Enable SVN Sharing**

Enables SVN Sharing.

Options: Enabled, Disabled

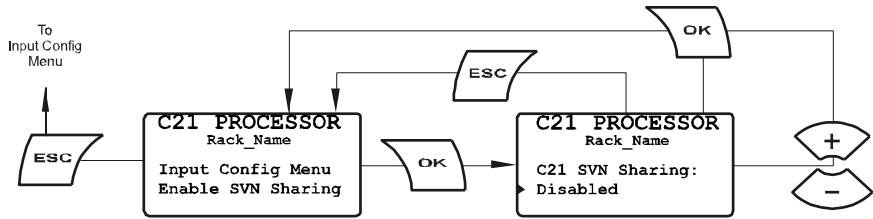

**SWC Menu**

SWC Menu

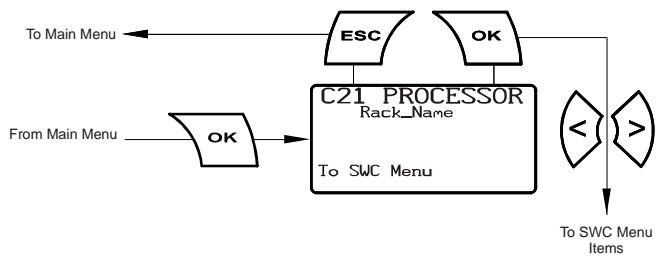

**Call SWC Preset**

Allows you to play-back one of the 128 SWC preset in the recorded time.

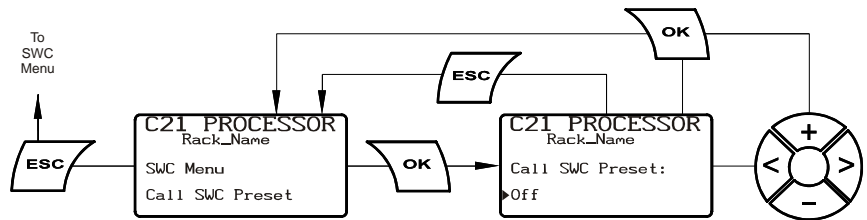

**Record SWC Preset**

Allows you to record to one of the 128 presets

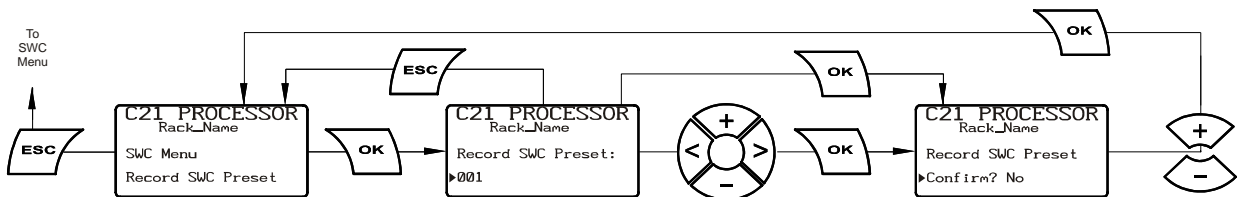

**Set No Mux Preset** Allows you to select one of the 128 presets as the No Mux Preset.

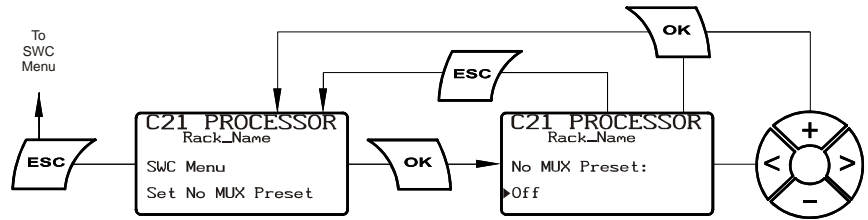

**Set No Mux Hold Time** Allows you to record a Hold Time for the No Mux Preset.

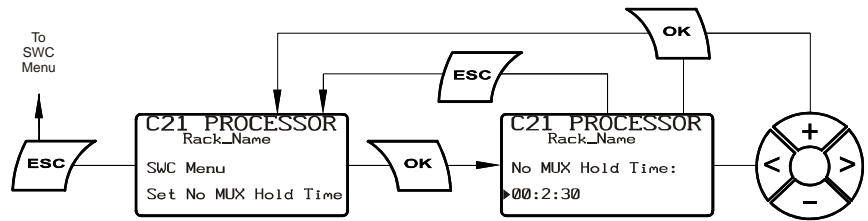

**Set No Mux NetSlot** Allows you to set the No Mux NetSlot number.

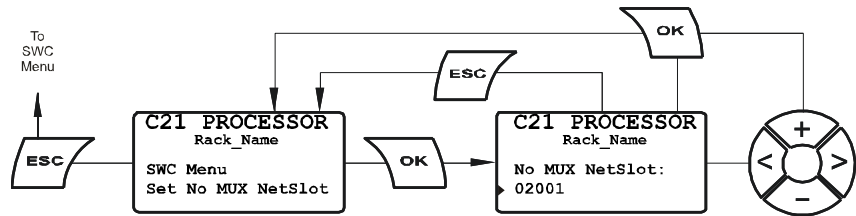

**Set Fade Time** Allows you to record a Fade Time for and individual SWC preset.

The default is 0:00:03 seconds.

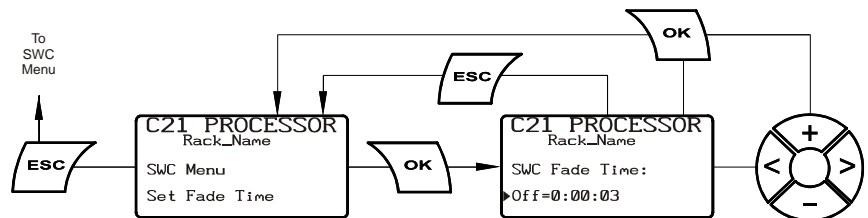

**Set Fade Time Range** Allows you to record a Fade Time for a range of SWC presets.

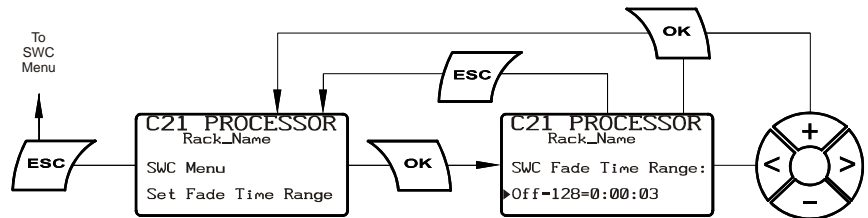

## Edit SWC Event List Editor

Allows you to view or edit 1 of 24 events which will automatically recall an SWC preset based on any day and time of the week.

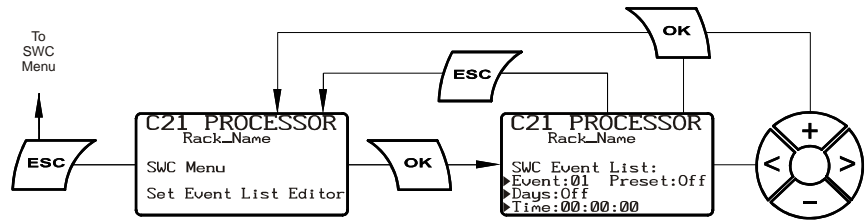

## Set Power-Up Preset

Allows you to set the power-up preset.

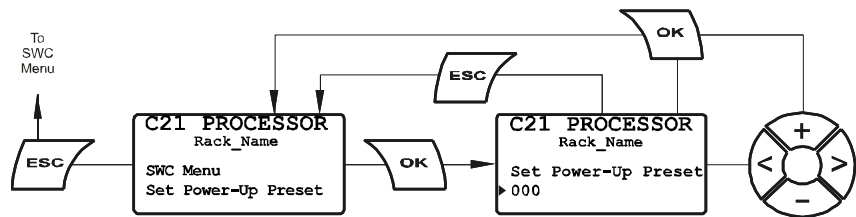

**Note:** Outlook is a legacy product. It can still be used to control the rack, but is no longer available from Vari-Lite.

## Outlook Menu

Outlook Menu

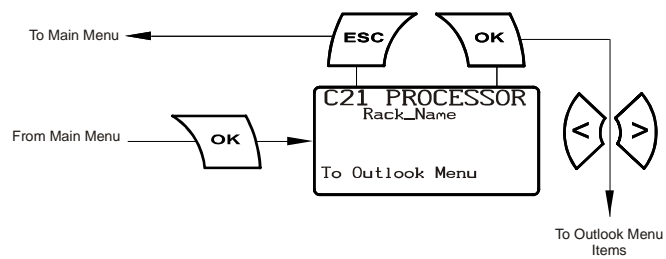

## Call Outlook Preset

Allows you to recall an Outlook preset in one of the 16 Outlook rooms.

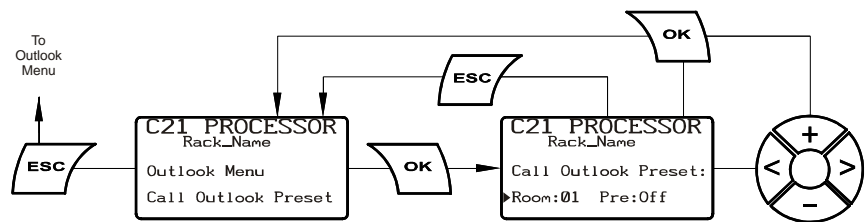



**Call Outlook Pr. Range**

Allows you to recall an Outlook preset in a range of Outlook rooms. (Feature currently not available).

**Record Outlook Preset**

Allows you to select the Outlook room and preset number to record.

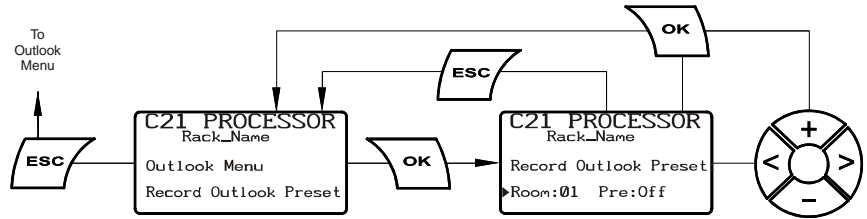

**Record Outlook Pr. Range**

Allows you to a range of Outlook rooms to record an Outlook preset into. (Feature currently not available).

**Set Channel Levels**

Set Channel Levels (Feature currently not available).

**Set Ch. Levels Range**

Set Ch. Levels Range (Feature currently not available).

**Set Outlook Fade Time**

Set Outlook Fade Time

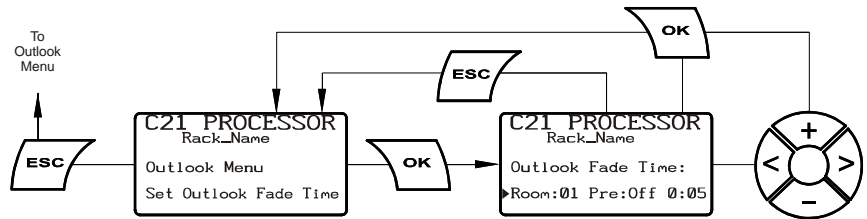

**Set Fade Time Range**

Set Fade Time Range (Feature currently not available).

**Set Power-up Preset**

Set Power-up Preset (Feature currently not available).

**Review Outlook Patch**

Review Outlook Patch

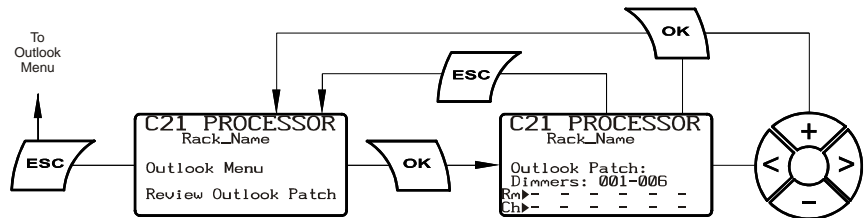

**Set Outlook Patch** Set Outlook Patch

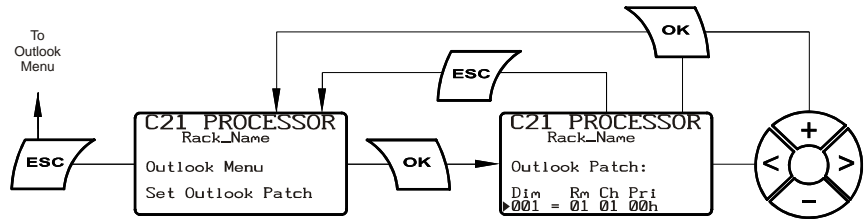

**Set Outlook Defaults** Sets Outlook Defaults.

Options: Yes, No

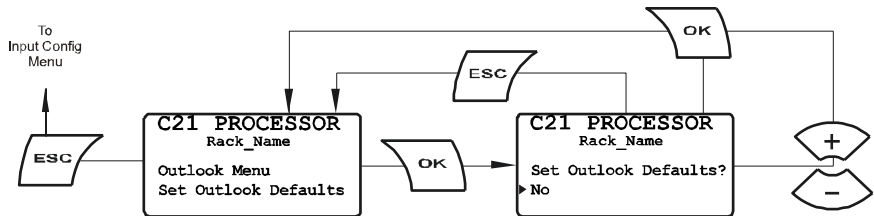

**Local Control Menu** Local Control Menu

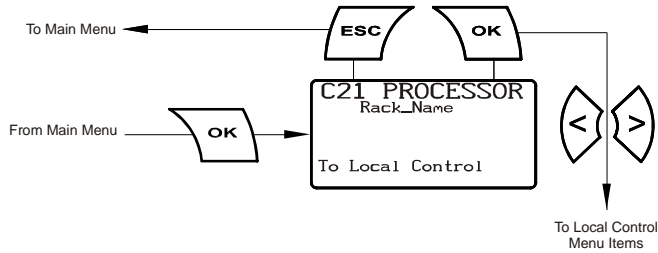

**Set Dimmer Level** Allows you to set an individual dimmer to INPUT or to a local level between 0% and FULL.

**Note:** Setting dimmer levels to something other than INPUT overrides the control inputs, including presets, you can easily loose control of dimmers by forgetting to set them back to INPUT. The levels set in this menu are remembered even when you shut down the rack.

You can use the Set Dimmer levels menu to set dimmer levels in order to record SWC and Outlook presets where there is no conventional lighting control system.

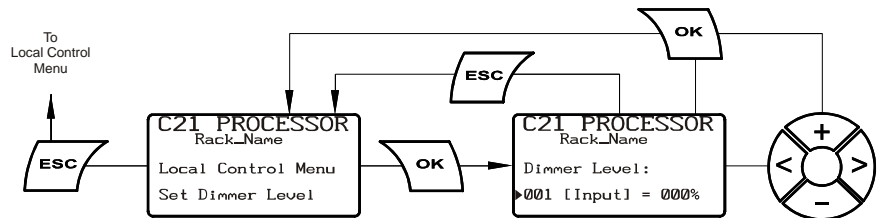

## Set Dimmer Level Range

Allows you to set a range of dimmers to INPUT or to a local level between 0% and FULL.

**Note:** Setting dimmer levels to something other than INPUT overrides the control inputs, including presets, you can easily lose control of dimmers by forgetting to set them back to INPUT. The levels set in this menu are remembered even when you shut down the rack.

You can use the Set Dimmer levels menu to set dimmer levels in order to record SWC and Outlook presets where there is no conventional lighting control system.

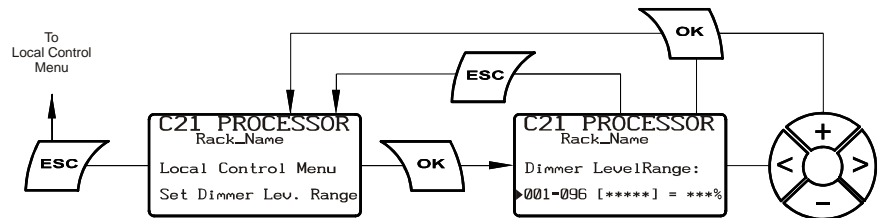

## Call SWC Preset

Allows you to recall one of the 128 SWC presets.

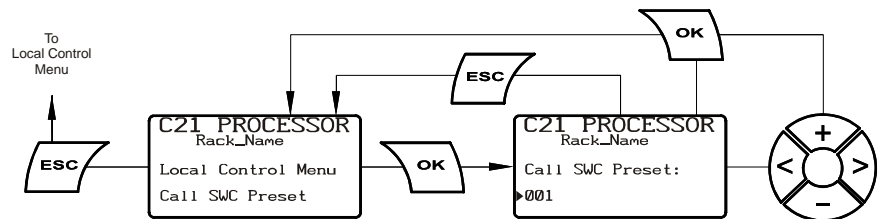

## Call Outlook Preset

Allows you to recall an Outlook Preset in one of the 16 rooms.

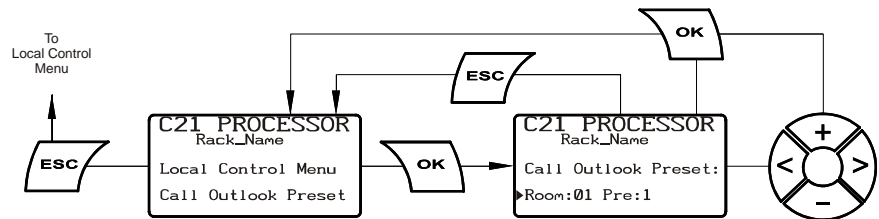

**Status Reporting Menu** Status Reporting Menu

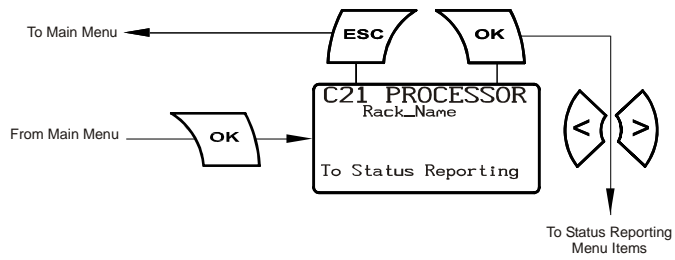

**View Live Status** View Live Status

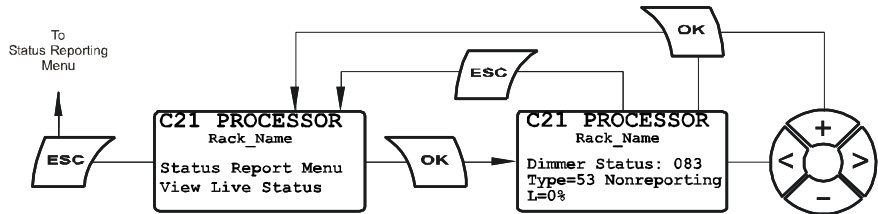

**View Rack Status** View Rack Status

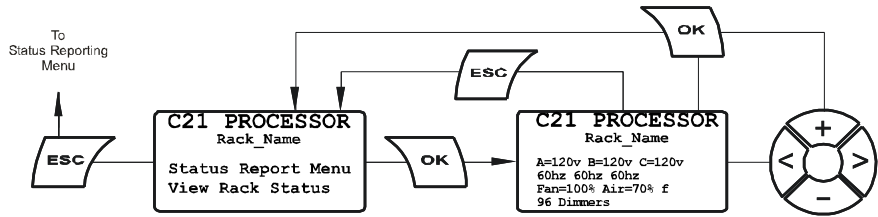

**View Event Log**

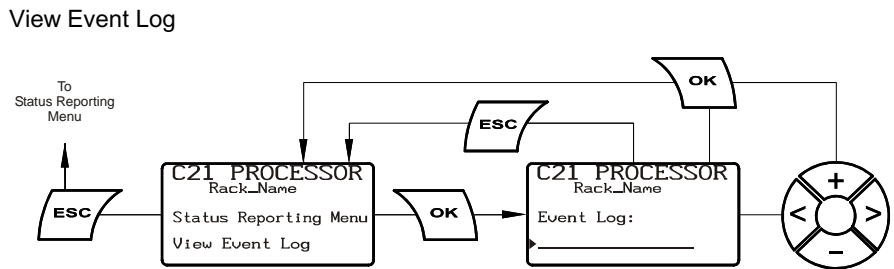

**View Profile Stats** View profile stats (Feature currently not available).

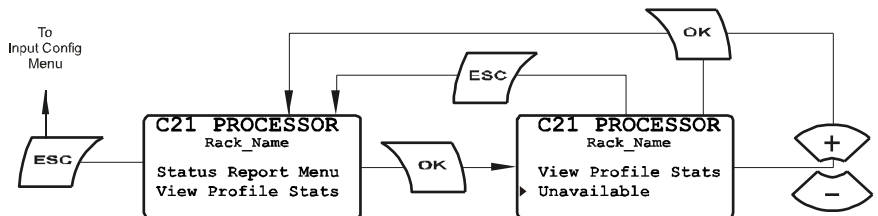

**View Comm Stats** View comm stats (Feature currently not available).

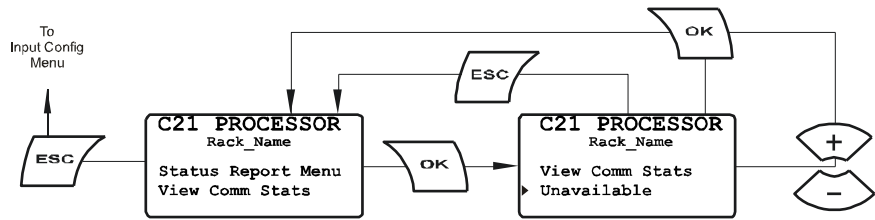

**View System Up-Time** View System Up-Time.

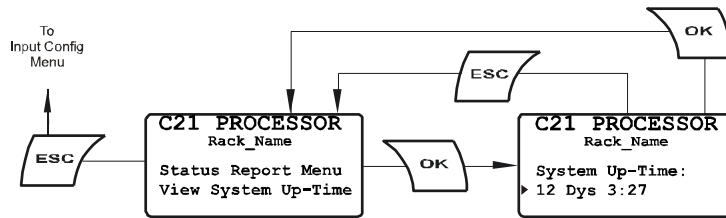

**Set Temperature Scale** Sets temperature scale

Options: Celsius, Fahrenheit

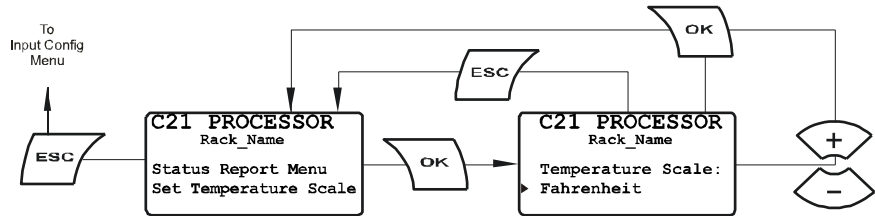

**Set Level Display** Sets Level Display

Options: Percent, Decimal, Hex

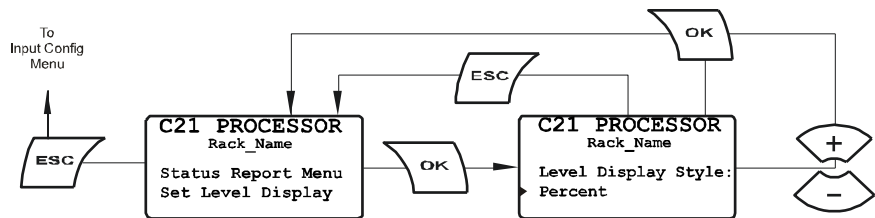

**Set Event Config** Sets event configuration (Feature currently not available).

Options: Unavailable

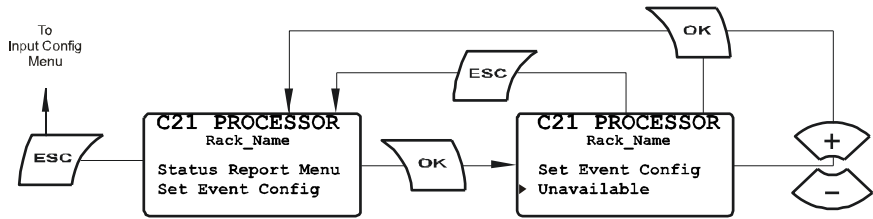

**Enable Load Errors** Enables load errors

Options: Enabled, Disabled

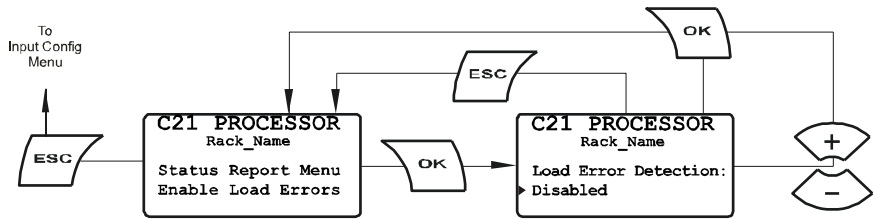

**Factory Menu** Factory Menu

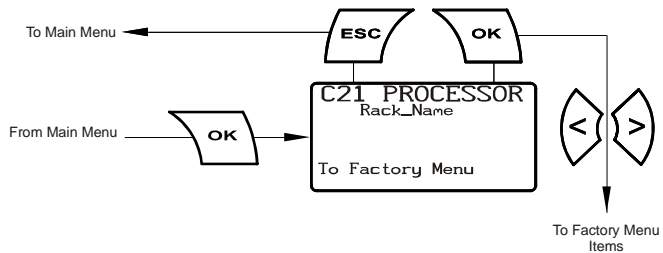

**Set Rack Model** Allows you to choose which rack model the processor is connect.

The options are:  
C21, EC21

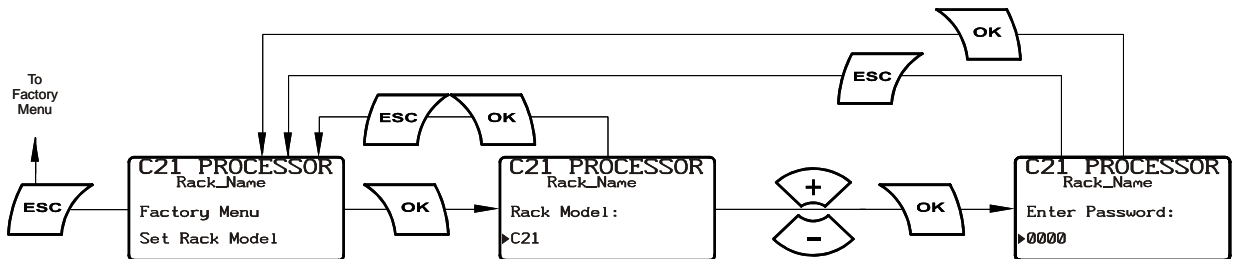

### Set Rack Backplane

Allows you to select the backplane settings for the dimmer rack.

The options are: Normal, Half, Quarter,

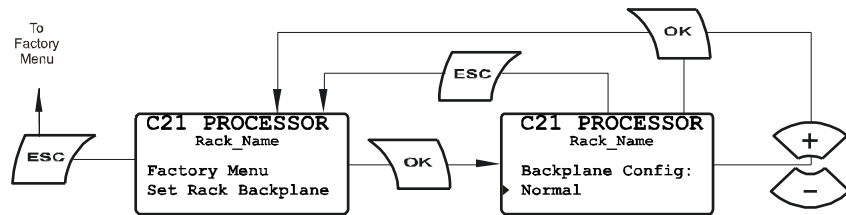

### Set Rack Mains

Allows you set the rack mains for 120V or 230V markets

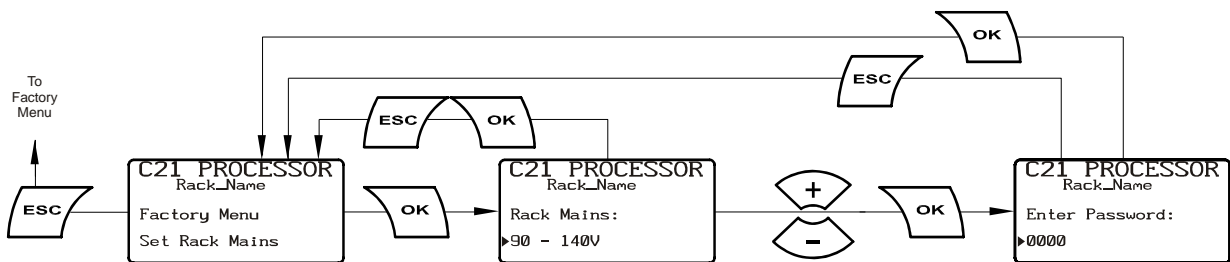

### Set Phase Config

Allows you to set the rack phases for the 120V and 230V markets

The rack mains can be configured for 120V markets:  
3-Phase: A-B-C-A-B-C or Single-Phase: A-A-A-C-C-C

The rack mains can be configured for 230V markets:  
L1-L2-L3-L1-L2-L3

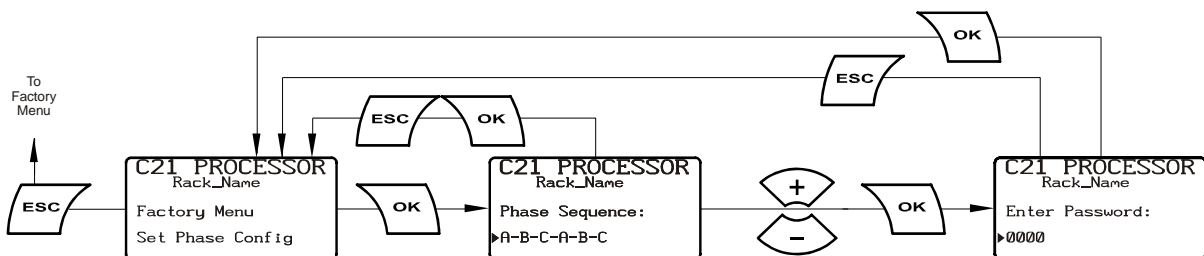

**Set Rack Size** Allows you to select the quantity of slots available in the dimmer rack.

The options are: 6, 12, 24, 36 or 48 slots

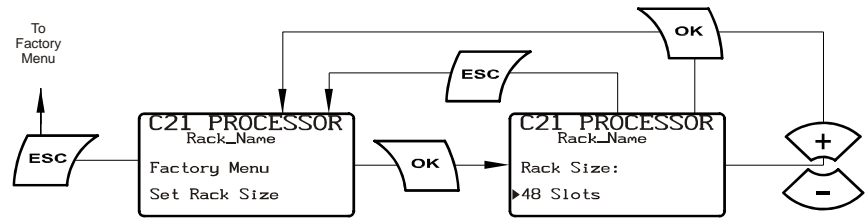

**Set Rack Slot Order** Allows you to choose if the slots are numbered horizontally or vertically through the dimmer rack.

If this option is set to horizontal, then the slots are numbered from 1 to 6, left to right across the top row. The slots in the second row are numbered from 7 to 12 and so on down all 8 rows.

The option is set to vertical, then the slots are numbers from 1 to 8 down the first column. The slots in the second column are numbered from 9 to 16 and so on across all 6 columns.

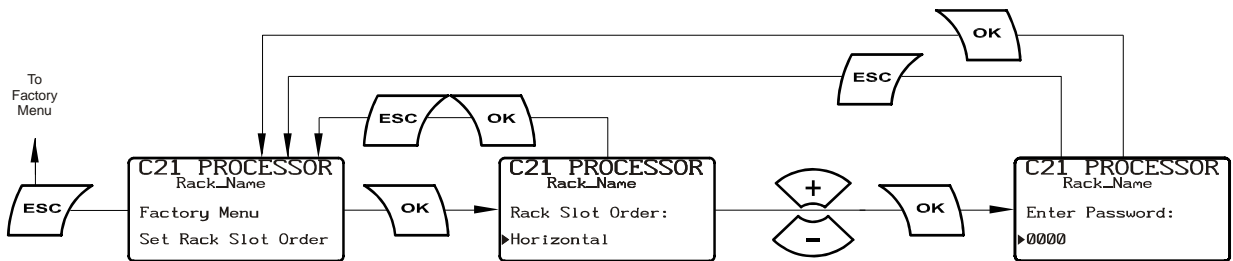

**Set Rack Slot Usage** Allows you to select the type of dimmer module that will be plugged into a dimmer rack slot.

The options are: Unused, Single, Dual, Quad

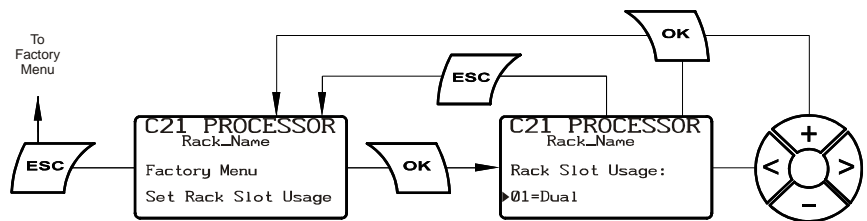



## Rack Calibration Sub-Menu

This option takes you to the rack calibration sub-menus.

## Set Phase Sense Trim

Allows you to set the amplifier gain for the line voltage sensing circuit. Generally this voltage is equal to the line input voltage for each phase. Adjusting the HEX value between 000 and 255 sets the voltage level.

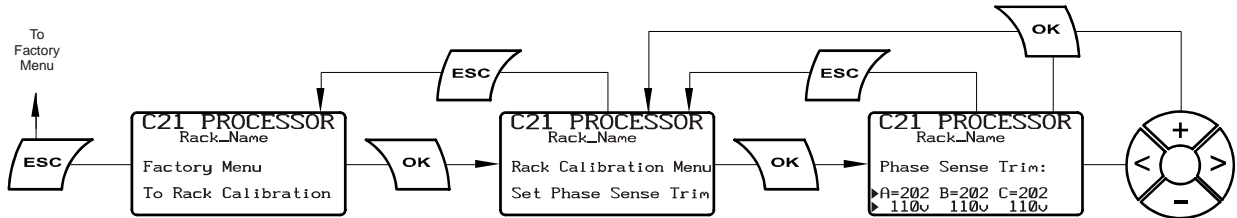

## Set Phase Filters

Allows you to set the width of the zero cross blanking period.

This function ensures that the processor module zero crossover time is synchronized with the mains. You must not activate this while a control signal is connected.

Default values: Width = 010 Lag = 000

**Note:** Do not calibrate the Phase Filters unless specifically advised to do so by a representative of Strand Lighting.

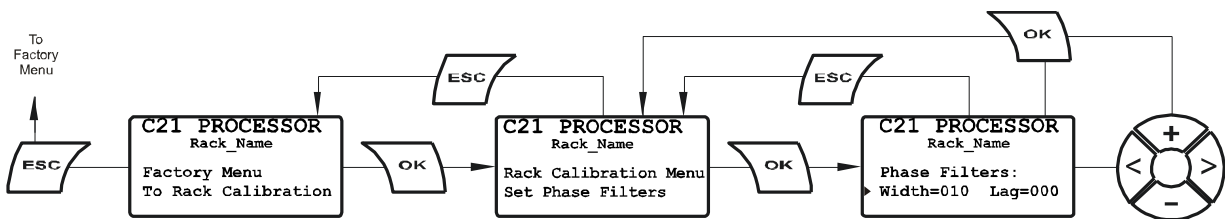

## Revert to Mfg. Config.

Allows you to set the rack back to factory defaults.

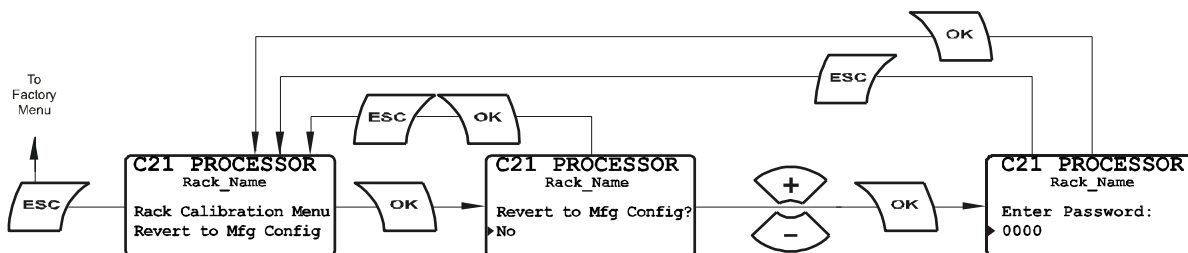

## EEPROM Test Write EEPROM Test Write

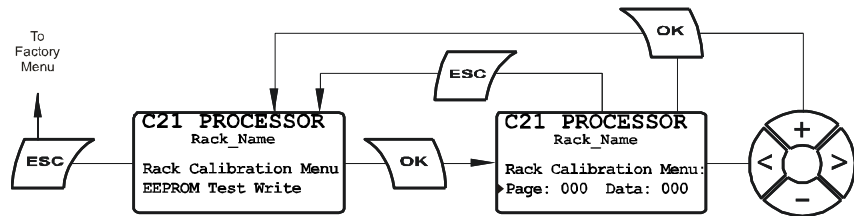

## EEPROM Test Read EEPROM Test Read

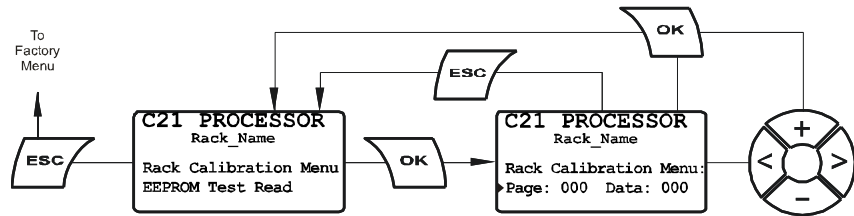

## View Serial Number Allows you to view the serial number.

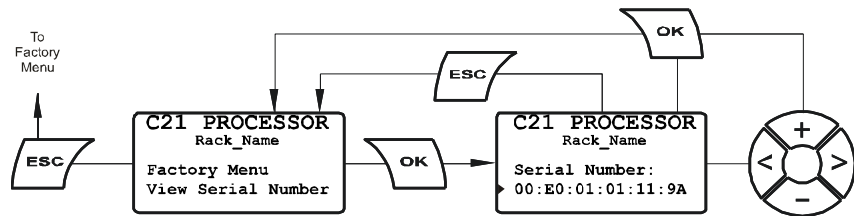

## Set Language Allows you to select the display language.

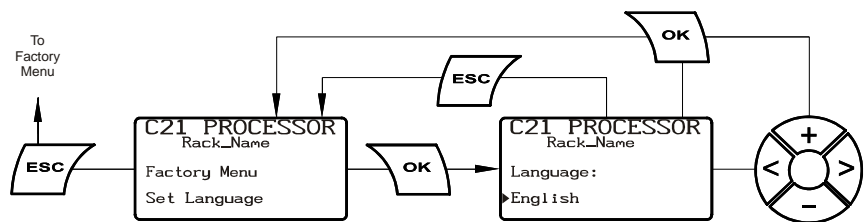

## Set Project Name Allows you to edit the Project name text field. This name is different than the one created in the *Network Config Menu* and is not viewed by the network.

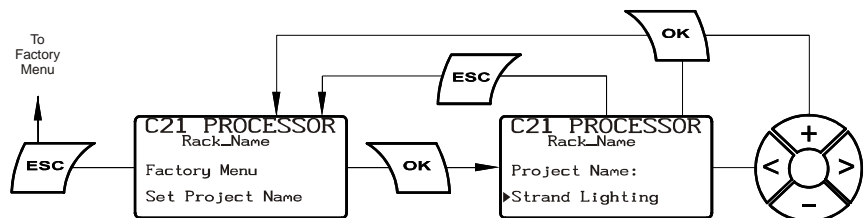

**Set Dealer Name** Allows you to edit the Dealer Name text field.

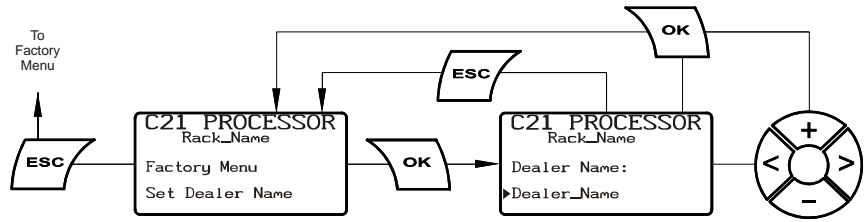

**Set Dealer Contact** Allows you to edit the Dealer Contact text field.

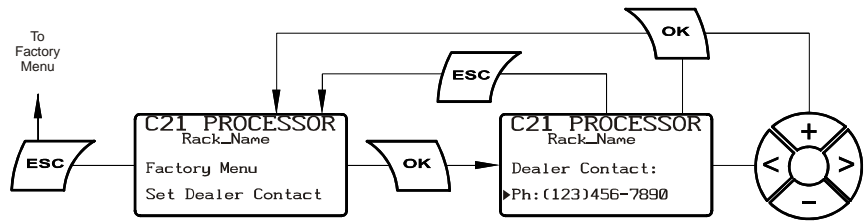

**Set Dealer Extra Info.** Allows you to edit the Dealer Extra Info text field.

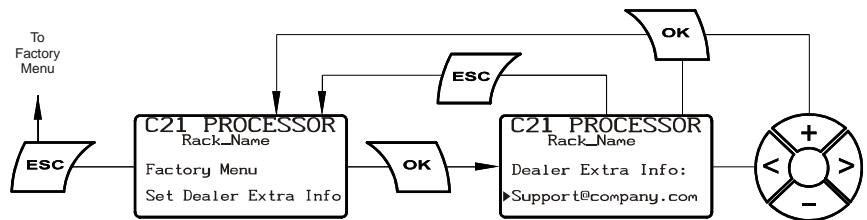

**Reboot Rack** Allows you to force a soft re-boot of the C21/EC21 operating system.

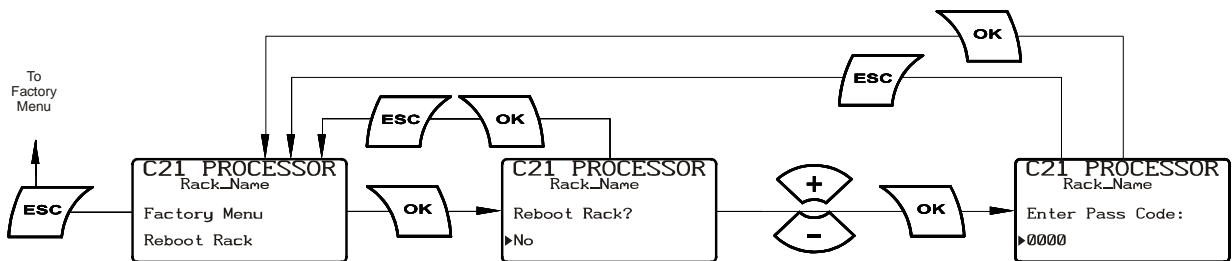

**Hide Factory Menu**

Allows you to hide this menu.

**Note:** *Selecting this option requires a special key sequence to un-hide the Factory Menu once it has been hidden.*

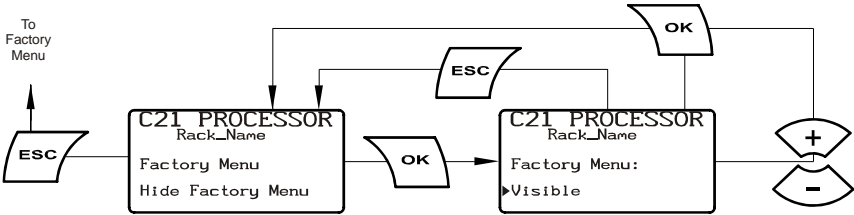

# Section 4 – C21/EC21 Web Pages

**General** This section provides basic information on the C21/EC21 Web Pages.

**Web Page Main Screen** Main Screen



**Web Page Authorization** Select [Home > Authorize] and enter the password: **2606** to become 'Privileged'.



**Web Page Setup**

Select [Home > Setup] to gain access to the following options:

- System
- Dimmer
- Patch
- SWC
- Outlook



**Web Page System Parameters**

Select [Home > Setup > System > Parameters]

Name	Rack Name	Uptime	1:30	Events	Temperature
Network Status	ShowNet - Inactive	DMX A (DmxPort1)	DMX In - Inactive	DMX B (DmxPort2)	DMX In - Inactive
SWC Preset	0	Temperature °C	0	Fan Speed %	0
Mains Voltage	115,116,117	Mains Frequency (Hz)	60,60,60	Date/Time	2008-09-20 05:03:17
Main Processor	Ready	Backup Processor	Not Present	Privileged	No

[Home](#)
[Setup](#)
[System](#)
[Parameters](#)

Name	Rack_Name
Location	Rack_Location
Breaker Port	Main_Breaker_ID
Minimum Fan Speed %	40
Temperature Scale	Celsius
Key Lock Enabled	<input type="checkbox"/>
Preferred Processor	Main
LCD Backlight Idle	3
LCD Backlight Active	8
LCD Backlight Hold time	30
LCD Contrast	0
Blink LCD	<input type="checkbox"/>
Passcode	
Hostname	C21_72
IP Address	192.168.0.72
IP Netmask	255.255.255.0
Gateway	0.0.0.0
DMX A Mode	DMX in
DMX A Label	DmxPort1
DMX A Start Slot	1
DMX A End Slot	512
DMX A Starting Netslot	2001
DMX B Mode	DMX in
DMX B Label	DmxPort2
DMX B Start Slot	1
DMX B End Slot	512
DMX B Starting Netslot	3001
Panic Mode	Use Dipswitch
AV Port Enabled	<input checked="" type="checkbox"/>
Power-on SWC Preset	0
No MUX SWC Preset	None
No MUX Hold Time	<input type="checkbox"/> Forever
No MUX Netslot	Ho: 0 Min: 1 S: 0
No MUX Netslot	2001
Enable Cable Compensation	<input type="checkbox"/>
Enable Voltage Loss Compensation	<input type="checkbox"/>
Enable Load Error Reporting	<input checked="" type="checkbox"/>
Enable SMX Sharing	<input checked="" type="checkbox"/>
SMX Sharing Group	0
Enable SVII Sharing	<input type="checkbox"/>
System UID	4500
SMTP minimum severity	None
SMTP server address	0.0.0.0
SMTP sender address	
SMTP recipient address	



**Web Page System Construction**

Select [Home > Setup > System > Construction]

Name	Rack Name	Uptime	1:31	Events	Temperature
Network Status	Show/Net - Inactive	DMX A (DmxPort1)	DMX In - Inactive	DMX B (DmxPort2)	DMX In - Inactive
SWC Preset	0	Temperature °C	0	Fan Speed %	0
Mains Voltage	114,114,116	Mains Frequency (Hz)	60,60,60	Date/Time	2008-09-20 05:04:55
Main Processor	Ready	Backup Processor	Not Present	Privileged	No

Home Setup System **Construction**

Rack Model	C21
Mains Voltage Range	90-140
Mains Phase Sequence	A-B-C-A-B-C
Rack Size	48
Rack Slot Order	Horizontal
Phase Trim - 1	225
Phase Trim - 2	226
Phase Trim - 3	227
Phase Filter Trim	10
Phase Filter Lag	0
Dealer Name	Dealer_Name
Dealer Extra	support@company.com
Dealer Contact	ph: (123) 456-7890
Project Name	Your Project
Factory Menu Enabled	<input checked="" type="checkbox"/>

**Web Page Construction Slots**

Select [Home > Setup > System > Construction Slots]

Name	Rack Name	Uptime	1:32	Events	Temperature
Network Status	Show/Net - Inactive	DMX A (DmxPort1)	DMX In - Inactive	DMX B (DmxPort2)	DMX In - Inactive
SWC Preset	0	Temperature °C	0	Fan Speed %	0
Mains Voltage	114,114,116	Mains Frequency (Hz)	60,60,60	Date/Time	2008-09-20 05:05:10
Main Processor	Ready	Backup Processor	Not Present	Privileged	No

Home Setup System **Construction Slots**

Start Slot	End Slot	Configuration
1	48	Dual



**Web Page Dimmer  
Modules**

Select [Home > Setup > System > Modules]

The screenshot displays the C21 web interface. At the top left is the C21 logo. Below it is a system status table with the following data:

Name	Rack Name	Uptime	1:30	Events	Temperature
Network Status	ShowNet - Inactive	DMX A (DmxPort1)	DMX In - Inactive	DMX B (DmxPort2)	DMX In - Inactive
SWC Preset	0	Temperature °C	0	Fan Speed %	0
Mains Voltage	114,115,117	Mains Frequency (Hz)	60,60,60	Date/Time	2008-09-20 05:03:57
Main Processor	Ready	Backup Processor	Not Present	Privileged	No

Below the status table is a navigation menu with buttons for Home, Setup, System, and Modules. The Modules button is selected. Underneath the menu is a table for module configuration:

Start Slot	End Slot	Module Type
1	48	78563 - Dual 20A 600uS SCR

The background of the interface shows a close-up of a physical dimmer module with the 'strand' logo.

**Web Page Dimmer Circuits**

Select [Home > Setup > Dimmer > Circuits]

The screenshot displays the C21 web interface. At the top, there is a status bar with the following information:

Name	Rack_Name	Uptime	1:33	Events	Temperature
Network Status	Show/let - Inactive	DMX A (DmxPort1)	DMX In - Inactive	DMX B (DmxPort2)	DMX In - Inactive
SWC Preset	0	Temperature °C	0	Fan Speed %	0
Mains Voltage	114,114,116	Mains Frequency (Hz)	60,60,60	Date/Time	2008-09-20 05:06:50
Main Processor	Ready	Backup Processor	Not Present	Privileged	No

Below the status bar, there are navigation tabs: Home, Setup, Dimmer, and Circuits. The 'Circuits' tab is selected, displaying a table of dimmer circuits:

Slot	Dimmer	Circuit	Impedance (mΩ)
1	1	00001	0
	2	00002	0
2	3	00003	0
	4	00004	0
3	5	00005	0
	6	00006	0
4	7	00007	0
	8	00008	0
5	9	00009	0
	10	00010	0
6	11	00011	0
	12	00012	0
7	13	00013	0
	14	00014	0
8	15	00015	0
	16	00016	0
9	17	00017	0
	18	00018	0
10	19	00019	0
	20	00020	0
11	21	00021	0
	22	00022	0
12	23	00023	0
	24	00024	0
13	25	00025	0
	26	00026	0
14	27	00027	0
	28	00028	0
15	29	00029	0
	30	00030	0
16	31	00031	0
	32	00032	0
17	33	00033	0
	34	00034	0
18	35	00035	0
	36	00036	0
19	37	00037	0
	38	00038	0
20	39	00039	0
	40	00040	0
21	41	00041	0
	42	00042	0
22	43	00043	0
	44	00044	0
23	45	00045	0
	46	00046	0
24	47	00047	0
	48	00048	0

**Web Page Dimmer Dynamics**

Select [Home > Setup > Dimmer > Dynamics]



**Web Page Dimmer User Profiles**

Select [Home > Setup > Dimmer > User Profiles]





**Web Page Dimmer**  
**Tolerance**

Select [Home > Setup > Dimmer > Tolerance]



**Web Page Dimmer**  
**Reporting**

Select [Home > Setup > Dimmer > Reporting]



**Web Page Dimmer Patch**

Select [Home > Setup > Patch > Dimmer]



**Web Page Firmware Update**

Select [Home > Setup > Firmware > Choose]





**Web Page Local Control**

Select [Home > Control > Local]

The screenshot displays the C21 web interface. At the top left is the C21 logo. Below it is a status bar with the following data:

Name	Rack Name	Uptime	1:38	Events	Temperature
Network Status	ShowNet - Inactive	DMX A (DmxPort1)	DMX In - Inactive	DMX B (DmxPort2)	DMX In - Inactive
SWC Preset	Off	Temperature °C	0	Fan Speed %	0
Mains Voltage	114,114,115	Mains Frequency (Hz)	60,60,60	Date/Time	2008-09-20 05:11:45
Main Processor	Ready	Backup Processor	Not Present	Privileged	Yes

Below the status bar are navigation buttons: Home, Control, and Local. The 'Local' button is selected. Above the table are 'Clear All' and 'Select All' buttons. The table below lists 46 circuits with their local mode and level controls.

Circuit	Local Mode	Level
00001	<input type="checkbox"/>	<< < > >>
00002	<input type="checkbox"/>	<< < > >>
00003	<input type="checkbox"/>	<< < > >>
00004	<input type="checkbox"/>	<< < > >>
00005	<input type="checkbox"/>	<< < > >>
00006	<input type="checkbox"/>	<< < > >>
00007	<input type="checkbox"/>	<< < > >>
00008	<input type="checkbox"/>	<< < > >>
00009	<input type="checkbox"/>	<< < > >>
00010	<input type="checkbox"/>	<< < > >>
00011	<input type="checkbox"/>	<< < > >>
00012	<input type="checkbox"/>	<< < > >>
00013	<input type="checkbox"/>	<< < > >>
00014	<input type="checkbox"/>	<< < > >>
00015	<input type="checkbox"/>	<< < > >>
00016	<input type="checkbox"/>	<< < > >>
00017	<input type="checkbox"/>	<< < > >>
00018	<input type="checkbox"/>	<< < > >>
00019	<input type="checkbox"/>	<< < > >>
00020	<input type="checkbox"/>	<< < > >>
00021	<input type="checkbox"/>	<< < > >>
00022	<input type="checkbox"/>	<< < > >>
00023	<input type="checkbox"/>	<< < > >>
00024	<input type="checkbox"/>	<< < > >>
00025	<input type="checkbox"/>	<< < > >>
00026	<input type="checkbox"/>	<< < > >>
00027	<input type="checkbox"/>	<< < > >>
00028	<input type="checkbox"/>	<< < > >>
00029	<input type="checkbox"/>	<< < > >>
00030	<input type="checkbox"/>	<< < > >>
00031	<input type="checkbox"/>	<< < > >>
00032	<input type="checkbox"/>	<< < > >>
00033	<input type="checkbox"/>	<< < > >>
00034	<input type="checkbox"/>	<< < > >>
00035	<input type="checkbox"/>	<< < > >>
00036	<input type="checkbox"/>	<< < > >>
00037	<input type="checkbox"/>	<< < > >>
00038	<input type="checkbox"/>	<< < > >>
00039	<input type="checkbox"/>	<< < > >>
00040	<input type="checkbox"/>	<< < > >>
00041	<input type="checkbox"/>	<< < > >>
00042	<input type="checkbox"/>	<< < > >>
00043	<input type="checkbox"/>	<< < > >>
00044	<input type="checkbox"/>	<< < > >>
00045	<input type="checkbox"/>	<< < > >>
00046	<input type="checkbox"/>	<< < > >>

---

**Notes**

# TECHNICAL SUPPORT

## GLOBAL 24HR TECHNICAL SUPPORT:

Call: +1 214 647 7880

[entertainment.service@signify.com](mailto:entertainment.service@signify.com)

## NORTH AMERICA SUPPORT:

Call: 877-VARI-LITE (877-827-4583)

[entertainment.service@signify.com](mailto:entertainment.service@signify.com)

## EUROPEAN CUSTOMER SERVICE CENTER:

Call: +31 (0) 543 542 531

[entertainment.europe@signify.com](mailto:entertainment.europe@signify.com)

© 2022 Signify Holding. All rights reserved. All trademarks are owned by Signify Holding or their respective owners. The information provided herein is subject to change, without notice. Signify does not give any representation or warranty as to the accuracy or completeness of the information included herein and shall not be liable for any action in reliance thereon. The information presented in this document is not intended as any commercial offer and does not form part of any quotation or contract, unless otherwise agreed by Signify. Data subject to change.