

VLZ PROFILE Luminaire

► Photometric Data(Maximum zoom, Calibraton off)

Luminaire specifications

Optical system: Zoom range 6.3 to 54.5 degree @50%

Beam angle(50%):

Standard Mode:4.8 degree\16.7 degree\42.3 degree

Studio Mode:4.7 degree\16.6 degree\40.6 degree

Field angle(10%):

Standard Mode:6.2 degree\19.4 degree\44.3 degree

Studio Mode:6.3 degree\20.4 degree\47.3 degree

CRI: 78

Max Lumen: 24,286 @ 19°

Illuminance

Standard Mode:

DISTANCE	5M	10M	15M	20M
ANGEL	Lux	Lux	Lux	Lux
6.3°	44670	11220	4987	2807
21°	7614	2108	1069	595
54.5°	1285	388.3	197.3	105.6

Studio Mode:

DISTANCE	5M	10M	15M	20M
ANGEL	Lux	Lux	Lux	Lux
6.3°	30650	7788	3453	1964
21°	5442	1468	737.3	416.2
54.5°	881.2	264.5	135.6	72.6

Light output

Standard Mode:

ANGEL	Total(lumens)	Power(watts)	Efficacy(lm/W)
6.3°	10034	1000	10
21°	21483	1000	21.5
54.5°	16882	1000	16.9

Studio Mode:

ANGEL	Total(lumens)	Power(watts)	Efficacy(lm/W)
6.3°	7498.7	1000	7.5
21°	14970	1000	15
54.5°	11716	1000	11.7

Full intensity(Standard Mode)

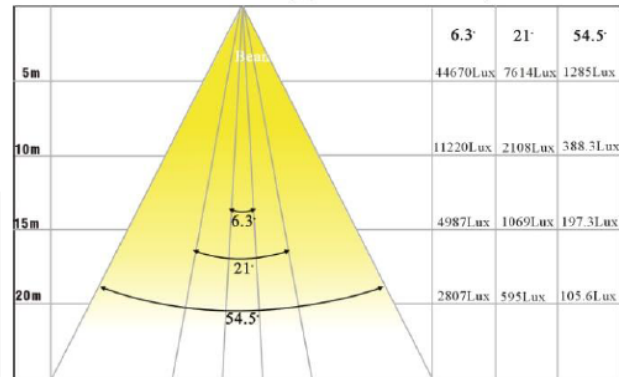

Full intensity(Studio Mode)

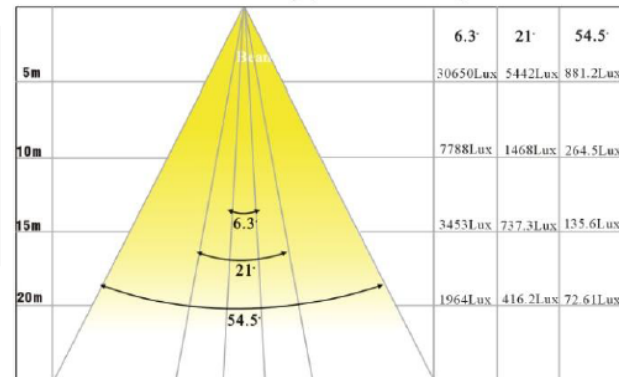

VLZ PROFILE Luminaire

Light distribution

Standard Mode:

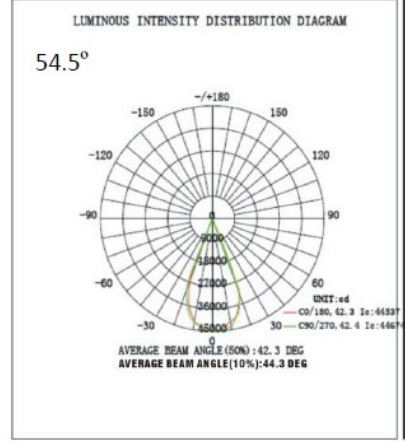
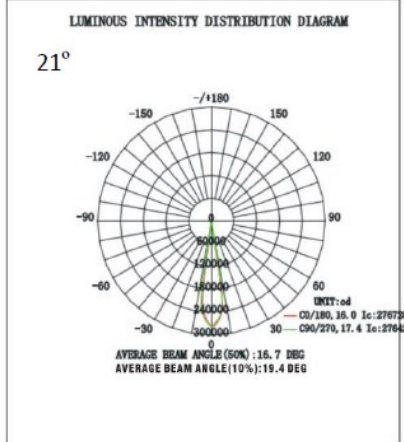
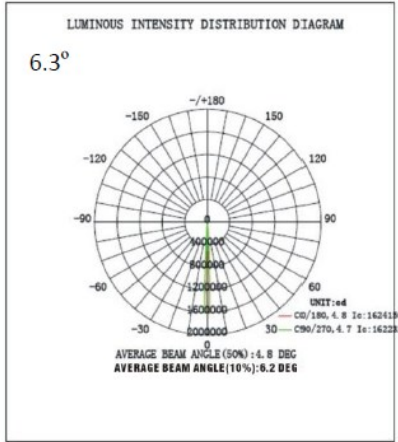

Standard Mode:

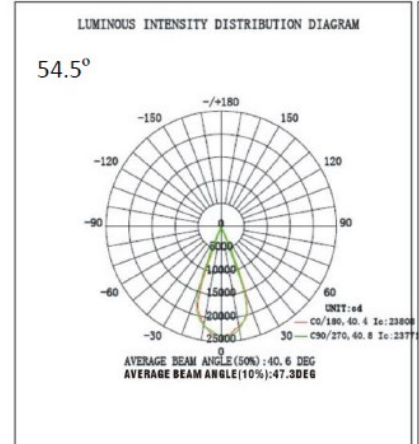
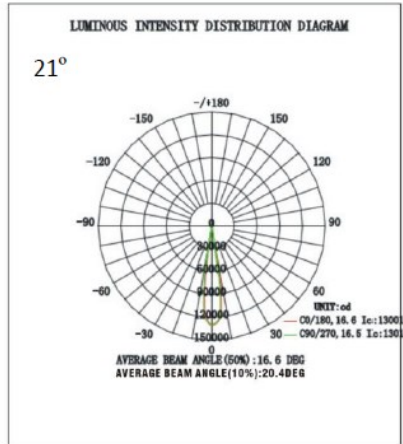
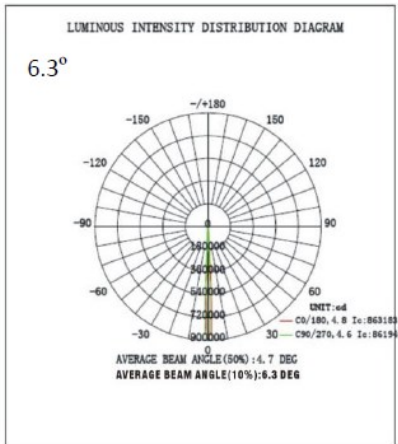

VLZ PROFILE Luminaire

Isolux diagram

Standard Mode:

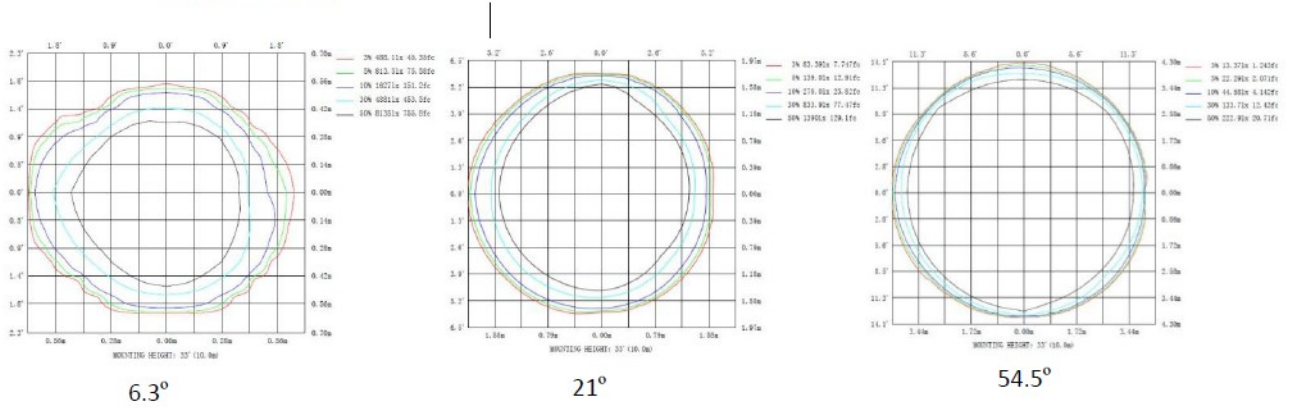

Standard Mode:

